

ENTRY STEP SYSTEM | INTERIOR | STEP COVER SYSTEMS

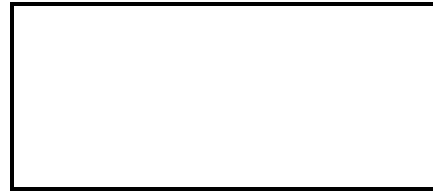

Generic Representation
of Step Cover System



Generic Representation
of Serial Number Sticker

OEM (OEM Related Documents: ml56050.html)	STEP COVER KIT (# SOLD TO OEM) (1ST SHIP DATE)	STEP COVER ASSEMBLY	CYL ASY (or) CYL/CTRL UNIT (MANIF/BLOCK) ASSY	MR48 PARTS MANUAL DIAGRAM & (MR40 OEM PAGE)
ATHENA MFG	N/A	AP46179 STEP CVR ASY 27.5	AP46075/RAP93204 CYL/BLOCK ASY 27.5 STCVR	"ATHENA MFG" NOT IN PM YET. athenadiagrams3.html
BRAKE ALERT	AP45772 STEP CVR KIT 27.5 (27.5) (NOT IN ML11428-40) (07JUN2010)	AP46179 STEP CVR ASY 27.5 (27.5)	AP46075/RAP93204 CYL/BLOCK ASY 27.5 STCVR	mr485010.html (MR40.0760.html)
CHARIOT VANS (See PACIFIC RULE ENTERPRISES)				
DOMINATOR INTERNATIONAL LTD	AP25366 STEP CVR KIT 30.0 (30.0) (24JUN2002)	N/A	AP28066 CYL ASY 0.75X30.0 STCVR	NO DIAGRAM LINK
DOMINATOR INTERNATIONAL LTD	AP28054 STEP CVR KIT 25.0 (25.5) (24JUN2002)	N/A	AP28065 CYL ASY 0.75X25.5 STPCVR	NO DIAGRAM LINK
FERRARA FIRE APPARATUS	N/A	AP40957 STEP CVR ASY 32.5 (32.5)	AP41076/RAP92119 CYL/BLOCK ASY 32.5 STCVR	mr485010.html (MR40.2020.html)
FORETRAVEL	N/A	N/A	AP39775/RAP92115 CYL/BLOCK ASY 26.0 STCVR	mr485010.html (mr402400.html)
KINGSLEY COACH	N/A	AP40957 STEP CVR ASY 32.5 (32.5)	AP41076/RAP92119 CYL/BLOCK ASY 32.5 STCVR	mr485010.html (MR40.3490.html)
LIFELINE SHELTER SYSTEMS	N/A	N/A	AP40083/RAP92116 CYL/BLOCK ASSY 26.0 STCVR	mr485010.html (MR40.3650.html)
LPD TRAILERS / KING OF THE ROAD	N/A	AP46179 STEP CVR ASY 27.5	AP46075/RAP93204 CYL/BLOCK ASY 27.5 STCVR	NO DIAGRAM LINK (MR40.3740.html)
OLYMPUS TECHNOLOGIES, INC.	N/A	N/A	AP39433/RAP92109 CYL/BLOCK ASY 26.0 STCVR	mr485010.html (MR40.5200.html)
PACIFIC RULE ENTERPRISES (USED TO BE CHARIOT VANS)	N/A	N/A	AP41189/RAP92120 CYL/BLOCK ASY 25.7 STCVR	mr485010.html CHARIOT VANS (MR40.1195.html)
RENEGADE / KIBBIE LLC	AP46775 34.5 STEP CVR KIT 34.5 (34.5) (NOT IN ML11428-40) (15JUN2010)	AP46521 STEP CVR ASY 34.5 (34.5)	AP40595/RAP92117 CYL/BLOCK ASY 34.5 STCVR	mr485010.html (MR40.5800.html)
TRIPLE E MFG	N/A	N/A	AP39433/RAP92109 CYL/BLOCK ASY 26.0 STCVR	mr485010.html (MR40.8250.html)

TSN TELECOMUNICACIONES, Y SERVICIOS DEL NORTE (aka TSN TELECOMUNICA) (aka TSN SECURITY & TELECOM)	AP45772 STEP CVR KIT 27.5 (27.5) (02MAR2010)	AP46179 STEP CVR ASY 27.5 (27.5)	AP46075/RAP93204 CYL/BLOCK ASY 27.5 STCVR	mr485010.html TSN Security & Telecom tsn.html
UNIVERSAL SPECIALTY VEHICLES	N/A	AP46521 STEP CVR ASY 34.5	AP40595/RAP92117 CYL/BLOCK ASY 34.5 STCVR	mr485010.html (MR40.8500.html)
N/A	N/A	AP40705 STEP CVR ASY 34.5 (34.5)	AP40595/RAP92117 CYL/BLOCK ASY 34.5 STCVR	NOT IN PM

ENTRY STEP SYSTEM | EXTERIOR | CASCADING STEP SYSTEM (CC)

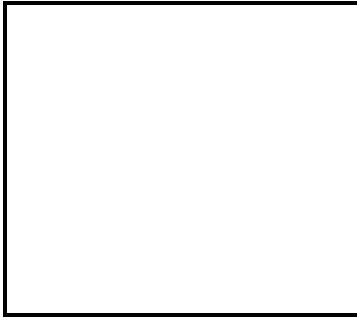

Generic Representation
of 3-STEP Cascading Step



Generic Representation
of Serial Number Sticker

OEM	STEP ASSEMBLY (# SOLD TO OEM) (1ST SHIP DATE)	STEP MECHANISM (1ST SHIP DATE)	STEP FRAMEWORK (1ST SHIP DATE)	MR48 PARTS MANUAL DIAGRAM & (MR40 OEM PAGE)
NEWMAR CORPORATION	AP55798 STEP ASY CC/3S/26.125 (06NOV2015)	AP55298 STEP MECH CC/3S/26.125 (31JUL17)	AP55823 STEP FRAMEWORK MTG CC/3S (06NOV15)	MR48CC_55798.HTML (mr404875.html)
WINNEBAGO IND		AP55570 STEP MECH CC/3S/23.375 (15SEP15)		NO DIAGRAM LINK (mr409250.html)

ENTRY STEP SYSTEM | EXTERIOR | FOLDING STEP SYSTEM (CM)

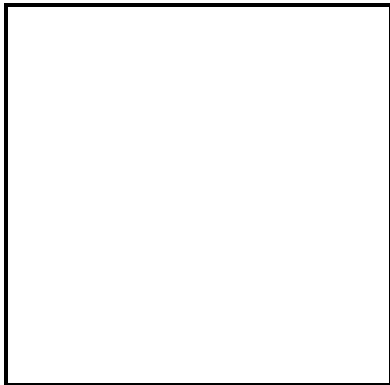

*Generic Representation
of Folding Step*

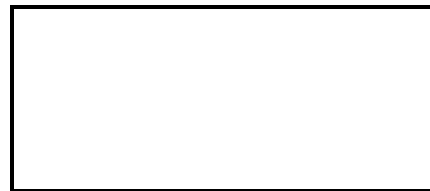

*Generic Representation
of Serial Number Sticker*

OEM	STEP ASSEMBLY (# SOLD TO OEM) (1ST SHIP DATE)	STEP ASSEMBLY (# SOLD TO OEM) (1ST SHIP DATE)	MR48 PARTS MANUAL DIAGRAM & (MR40 OEM PAGE)
ATHENA MFG		AP51938 STEP CM/4S/28.75/1H (21OCT2013)	MR48CM_*. * Coming Soon ATHENA IS NOT IN THE PM YET. athenadiagrams3.html
COMPETITIVE TRAILERS, INC		AP51822 STEP CM/4S/36.00/0H (10MAR2014)	MR48CM_*. * Coming Soon
COMPETITIVE TRAILERS, INC		AP49864 STEP CM/4S/36.00/2H (06MAR2012)	MR48CM_*. * Coming Soon MR40.1305.html
FARBER'S SPECIALTY VEHICLES		AP49596 STEP CM/4S/36/LHHNDL (27JAN2012)	MR48CM_*. * Coming Soon MR40.1800.html
FARBER'S SPECIALTY VEHICLES		AP50134 STEP CM/4S/36.00/LHHNDL (26APR2012)	MR48CM_*. * Coming Soon MR40.1800.html
FARBER'S SPECIALTY VEHICLES		AP56315 STEP CM/4S/28.75/1H (22APR2016)	MR48CM_*. * Coming Soon MR40.1800.html
FORETRAVEL INC		AP53022 STEP CM/4S/28.75/1R (04FEB14)	MR48CM_*. * Coming Soon mr402400.html
INTERCONTINENTAL TRUCK BODY		AP56513 STEP CM/4S/28.75/0H (05MAY2016)	MR48CM_*. * Coming Soon MR40.3305.html
K & D CUSTOM COACH INC		AP51938 STEP CM/4S/28.75/1H (07AUG2013)	MR48CM_*. * Coming Soon MR40.3435.html
K & D CUSTOM COACH INC		AP52642 STEP CM/5S/28.75/1A (24OCT2103)	MR48CM_*. * Coming Soon MR40.3435.html
K & D CUSTOM COACH INC		AP52057 STEP CM/5S/36.00/1H (08JUL2013)	MR48CM_*. * Coming Soon MR40.3435.html
LDS SYSTEMS INC (NO NCR WHERE USED)		AP55133 STEP CM/4S/36.00/2H (30APR2015)	MR48CM_*. * Coming Soon MR40.3610.html

LIFELINE MOBILE		AP45798 STEP CM/4S/34.00/0H (OLD OLD STYLE) (22FEB2010)	MR48CM_*. * Coming Soon
LIFELINE MOBILE		AP47923 STEP CM/4S/36.00/#H (NO ORDER ACTIVITY)	lifelinediagrams3.html
MICKEY TRUCK BODIES, INC.		AP52354 STEP CM/5S/28.75/1H (02OCT2013)	MR48CM_*. * Coming Soon MR40.3990.html
MOBILE SPECIALTY VEHICLES, INC (FORETRAVEL)		AP53022 STEP CM/4S/28.75/1R (09MAR2016)	MR48CM_*. * Coming Soon FORETRAVEL mr402400.html mobilespecialtydiagrams3.html
PIERCE MANUFACTURING		AP53022 STEP CM/4S/28.75/0H (NO ORDER HISTORY)	MR48CM_*. * Coming Soon MR40.5635.html
TSN TELECOMUNICACIONES, Y SERVICIOS DEL NORTE (aka TSN TELECOMUNICA) (aka TSN SECURITY & TELECOM)		AP45798 STEP CM/4S/34.00/0H (OLD OLD STYLE) (26FEB2010)	MR48CM_*. * Coming Soon tsn.html
UNIVERSAL SPECIALTY VEHICLES		AP53022 STEP CM/4S/28.75/1R (15FEB2016)	MR48CM_*. * Coming Soon MR40.8500
WINNEBAGO IND.	AP56565 STEP KIT CM WINN/SGL/NID (NO ORDER HISTORY)	AP56321 STEP CM/5S/36.00/2H (22MAR2016)	MR48CM_*. * Coming Soon MR40.9250.html

ENTRY STEP SYSTEM | EXTERIOR | STAIRWAY WITH PLATFORM & RAILS (ST)



Generic Representation of 5-STEP Stairway with Platform & Rails

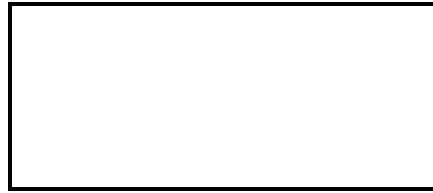

Generic Representation of Serial Number Sticker

OEM	STEP ASSEMBLY (# SOLD TO OEM) (1ST SHIP DATE)	MR48 PARTS MANUAL DIAGRAM & (MR40 OEM PAGE)
MOBILE SPECIALTY VEHICLES, INC (FORETRAVEL)	AP55578 STEP ST/5S FRTRVL & MSV (14SEP2015 \$0) AP55579 (NO ORDER HISTORY)	MR48ST_*. * Coming Soon FORETRAVEL mr402400.html mobilespecialtydiagrams3.html

HWH SPACEMAKER STEP SYSTEM

Exterior Step System: Cascading Step Mechanism

AP55798 Step Assembly (Includes Step Mechanism plus Framework) | **AP55298** Step Mechanism

3 Steps | 26.125" Step Width

(NOTE: Early 2017 models had cylinders mounted in a different location than shown below.)

(File: MR48CC_55798.doc | Revised: 08JUN17)







[Print Friendly PDF File](#)

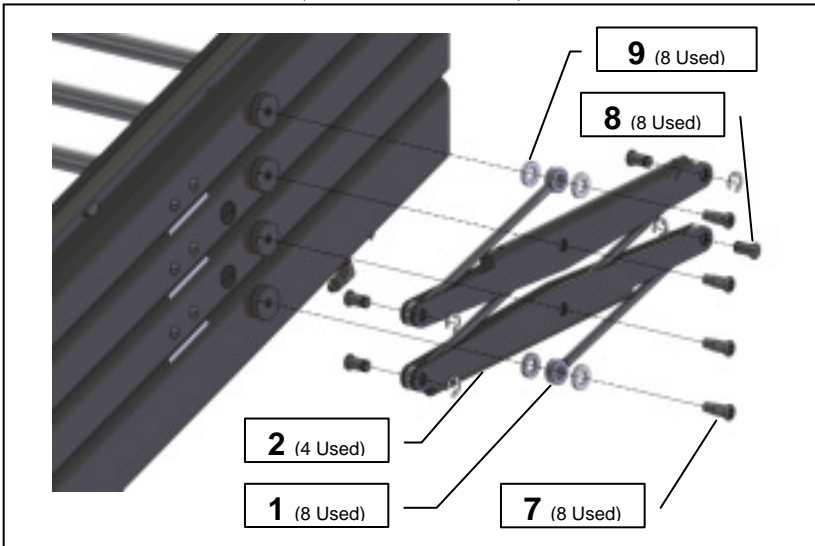
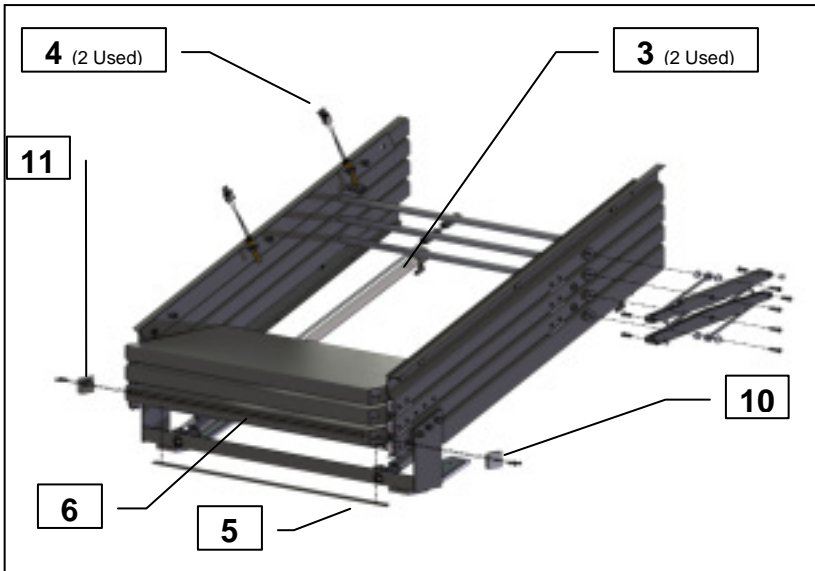



IDENTIFICATION STICKER:

I.D. sticker is located on the step mechanism.
The "**AP55798**" number is the OEM HWH Assembly Number.

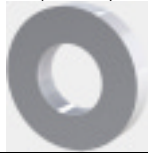

"R" ORDER #	
KIT DESCRIPTION (MFR #)	
INSTRUCTION SHEET LINK	
1	<p>RAP55304 LINKAGE WELDMENT (AP55304)</p> 
2	<p>RAP55396 LINKAGE WELDMENT BRACKET (AP55396)</p> 
3	<p>RAP55558 CYL ASSY 0.750 X 24.750 (AP55558) RAP Includes 4 SNAP RINGS</p> 
4	<p>RAP90590 SWITCH LIMIT MAGNETIC N.O. (AP14079)</p> 
5	<p>RAP56017 SWITCH CURB FEELER (AP56017) INSTRUCTIONS: MI158815</p> 
6	<p>RAP56032 SWITCH SHIN GUARD (AP56032) INSTRUCTIONS: MI158815</p> 
7	<p>RP55257 BOLT SHOULDER (P55257)</p> 

8	<p>RP55274 PIN 0.375 DOME HEAD (P55274)</p> 
9	<p>RP55287 WASHER 0.750 OD (P55287)</p> 
10	<p>RP56437 PAD STEP 1.500 (P56437)</p>  <p>Material is black. (Shown lighter to highlight detail.)</p>
11	<p>RP57082 PAD STEP 1.500 GROOVE (P57082)</p>  <p>Material is black. (Shown lighter to highlight detail.)</p>
S O	<p>RAP93775 SPECIAL ORDER ONLY LOWER STEP ASSEMBLY</p>
S O	<p>RX93781 SPECIAL ORDER ONLY AP55298 STEP MECH 26.125/3S/CC MINUS THE TWO AP55558 CYLINDERS</p>

HWH SPACEMAKER STEP MECHANISM

“INTERIOR STEP COVER” MECHANISM *with*

WITH MANIFOLD ASSEMBLY

(File: MR48.5010.DOC | Revised: 20MAR17)

[Print Friendly PDF File](#)

The diagrams below represent the **BASE MODEL INTERIOR STEP COVER MECHANISM** as described above.

The information on this page is similar in all adaptations of the base model.

* SpaceMaker parts that have been adapted to OEM specifications can be found in the **OEM-Specific Parts Guide ? [MR40.HTML](#)**.

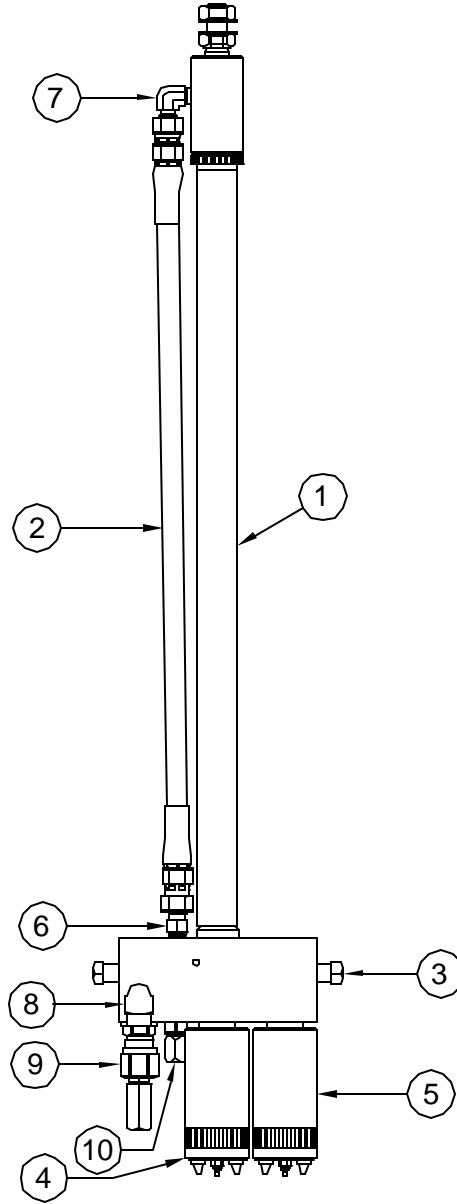

ITEM	ORDER#	QTY	DESCRIPTION
1*		1	CYLINDER ASSEMBLY <i>(Replacement cylinder includes all items on this page.)</i>
2*		1	HOSE ASSEMBLY
3	RP92112	2	TRUNION BOLT KIT
4	RAP90729	1	SOLENOID VALVE
5	RAP92108	1	SOLENOID VALVE <i>(HI-FLOW)</i>

ITEM	ORDER#	QTY	DESCRIPTION
6	RF1456	1	4-FTX-S MALE CONN.
7	RF1453	1	4-CTX-S ELBOW
8	RF3474	1	2202P-4-2 ELBOW (BRASS)
9	RF1458	1	68NTA-8-4 1/2" TUBE X <i>(1/4" NPT BRASS)</i>
10	RAP92110	1	CHECKED MALE CONN.

NOTE: INDENTED ITEMS INCLUDED WITH PRECEDING ITEM.