



# REPAIR MANUAL

**HWH SPACEMAKER ROOM EXTENSION  
310 OR 610 SERIES LEVELING SYSTEM  
FOR WINNEBAGO MOTORIZED VEHICLES**

**FEATURING:**

***ONE - DUAL CYLINDER ROOM EXTENSION  
(WITH SYNCHRONIZING CYLINDER)***

***OR***

***ONE - FLAT FLOOR ROOM EXTENSION  
(WITH SYNCHRONIZING CYLINDER)***

***AND***

***ONE - FOUR CYLINDER ROOM EXTENSION  
(WITH SYNCHRONIZING CYLINDER)***

**HWH CORPORATION  
(ON I-80, EXIT 267 SOUTH)  
2096 MOSCOW ROAD  
MOSCOW, IOWA 52760  
(800) 321-3494 / (563) 724-3396  
INTERNET: <http://www.hwhcorp.com>**

# SECTION 1

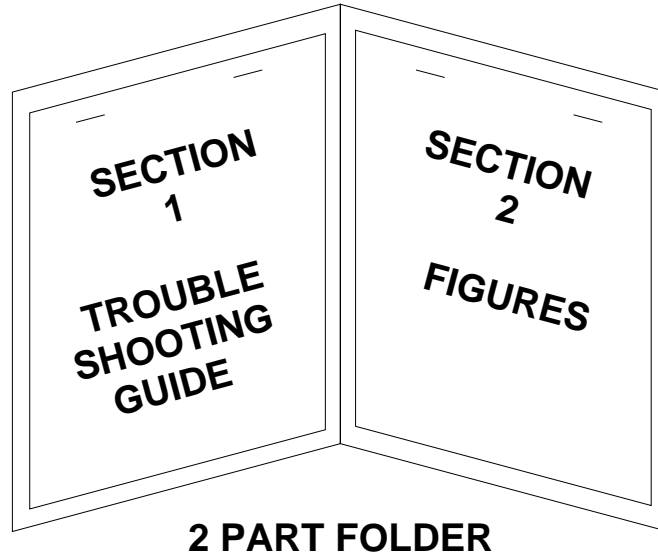

## HOW TO USE MANUAL

**IMPORTANT:** The four cylinder system incorporates pressure switches on the synchronizing cylinder to protect the system from damage due to high pressure. **DO NOT** operate the room with the pressure switches disconnected. If a pressure switch is tripped, the pump will not run when trying to operate the four cylinder room extension. A tripped pressure switch will not interfere with the operation of the front room.

This manual is written in two sections. Section 1 is the Trouble Shooting Guide. Section 2 is the figures. Begin diagnosis of the system with Section 1, the Trouble Shooting Guide. The Trouble Shooting Guide is broken into 3 columns, Problem, Solutions and Figures. Under Problems, find the symptom you have encountered. The testing and repair for that problem is in the Solution (center) column. Diagrams for a particular Problem and Solution are in the Figures (right hand) column. This column will direct you to the proper figure in Section 2, Figures, for a more detailed view.

Before beginning your repair, it is **IMPORTANT** to read the **CAUTIONS** and **NOTES AND CHECKS** in the first section, **TROUBLE SHOOTING GUIDE**. In many cases this will save time and mistakes when trouble shooting a system.

This Repair Manual is offered as a guide only. It is impossible to anticipate every problem or combination of problems. For any problems encountered that are not addressed in this manual, contact HWH Corporation for assistance. (800-321-3494)

The room should be fully retracted before Trouble Shooting the system. If the room will not retract, use the manual retract procedure on pages MP35.9490 and MP35.952D.

**Make sure all room locks and the manual retract winch are not engaged before trouble shooting the system.**

**PROCEED WITH TROUBLE SHOOTING GUIDE**



# TROUBLE SHOOTING

## WARNING!

**BLOCK FRAME AND TIRES SECURELY BEFORE CRAWLING UNDER VEHICLE. DO NOT USE THE LEVELING JACKS OR AIR SUSPENSION TO SUPPORT VEHICLE WHILE UNDER VEHICLE OR CHANGING TIRES. VEHICLE MAY DROP AND OR MOVE FORWARD OR BACKWARD WITHOUT WARNING CAUSING INJURY OR DEATH.**

**KEEP PEOPLE AND OBJECTS CLEAR OF THE ROOM EXTENSION WHEN IT IS BEING OPERATED. MAKE SURE THERE IS AMPLE ROOM TO EXTEND THE ROOM FULLY.**

**WHEN ROUTING OR REROUTING HYDRAULIC HOSES AND WIRES, BE SURE THEY ARE NOT EXPOSED TO ENGINE EXHAUST OR ANY HIGH TEMPERATURE COMPONENTS OF THE VEHICLE.**

**NEVER PLACE HAND OR OTHER PARTS OF THE BODY NEAR HYDRAULIC LEAKS. OIL MAY CUT AND PENETRATE THE SKIN CAUSING INJURY OR DEATH.**

**SAFETY GLASSES ARE TO BE WORN TO PROTECT EYES FROM DIRT, METAL CHIPS, OIL LEAKS, ETC. FOLLOW ALL OTHER SHOP SAFETY PRACTICES.**

## NOTES AND CHECKS

**Read and check before proceeding with Trouble Shooting Steps.**

**NOTE: HWH CORPORATION ASSUMES NO LIABILITY FOR DAMAGES OR INJURIES RESULTING FROM THE INSTALLATION OR REPAIR OF THIS PRODUCT.**

1. If the room extension cannot be retracted, see Figures pages MP35.9490 and MP35.952D for temporary measures. Make sure the manual retract valves are closed before trouble shooting.
2. The room extension can be operated any time the park brake is set. The ignition does not have to be in the ON or ACC position.
3. **Make sure the leveling system operates properly. Some problems encountered with the leveling system may create a problem with the room extension.**
4. Check that the oil reservoir is full with the room in the fully retracted position.
5. Batteries should read 12.6 volts. Batteries must be in good condition with no weak cells. An alternator, converter or battery charger will not supply enough power for the system to operate properly. Check between the positive and negative posts of the battery while the pump is running. This will check the battery condition under load.

6. Proper ground of all components is critical. See the electrical circuit for specific grounds required. Faulty grounds, especially for the solenoid manifold or the pump assembly, may cause component damage and /or improper or erratic operation.

**This manual is intended for use by experienced mechanics with knowledge of hydraulic and automotive electrical systems. People with little or no experience with HWH Room Extension systems should contact HWH technical service (800-321-3494) before beginning. Special attention should be given to all cautions, wiring, and hydraulic diagrams.**

**Tightening of hose ends: If tightening a new hose end, make the hose end snug (finger tight) on the fitting, then tighten the hose end 1/3 turn (2 FLATS). If tightening an existing hose end, tighten the hose end to snug plus 1/4 turn (1 FLAT).**

Suggested tools for trouble shooting the HWH room extension systems:

JUMPER WIRES(UP TO 10 GAUGE)  
PRESSURE GAUGE(3500 PSI MIN.)  
MULTI-METER  
12 VOLT TEST LIGHT

**PROCEED WITH THE TROUBLE SHOOTING STEPS ON THE FOLLOWING PAGE**



# TROUBLE SHOOTING

The following is a list of possible problems and solutions which might occur to room extensions. There will be only one power unit / valve assembly to operate the room extension(s) and leveling system. There will be a room control switch for each room extension.

If the leveling system does not operate properly, the room extension(s) may not operate properly.

Unless otherwise noted, the PROBLEM and SOLUTION is for either the FLAT FLOOR or DUAL CYLINDER room extensions with a synchronizing cylinder or the SINGLE CYLINDER GUIDED room extension with any leveling system.

## PROBLEM

## SOLUTION

## FIGURES

**Part 1**  
Neither room will extend or retract. The pump will not run.

**NOTE: The room control switch and the harness through the coach is supplied by Winnebago.**

**Only the PARK BRAKE needs to be set for the rooms to operate. The IGNITION can be OFF.**

If the LEVELING SYSTEM is functioning properly, that should indicate that the PARK BRAKE is set, there is battery power to the relays on the pump and that the pump is functioning.

Check terminal B of the room extension pump relay for +12 power. If power is not present there is a problem with that connection.

Check terminal D for a ground. If there is no ground present, there is a problem with the connection at terminal D or a problem with the 9000 wire in the LEVELING SYSTEM MANIFOLD PUMP HARNESS.

If there is power on terminal B and a good ground for terminal D, check the 20 AMP fuse in the 6101 wire from terminal C. This supplies +12 battery power to the room control switches.

**If the fuse is blown**, replace the fuse. If the fuse blows immediately, the HWH 6101 wire or the Winnebago CCT wire is shorted to ground. If the fuse does not blow, retry either room. If the fuse does not blow continue testing the system. If the fuse blows, remove the 8602 wire from the pump relay, try the front room. If the fuse blows, the HWH 8602 wire or the Winnebago DDA wire is shorted to ground. If the fuse does not blow, remove the 8603 wire from the pump relay. Try the rear room. If the fuse blows, the HWH 8601 or 8603 wire, the interrupt relay on the pump, or the Winnebago DDK wire is shorted to ground. If the fuse does not blow, reattach the 8602 and 8603 wires to the pump relay and retry either room. If the fuse blows, replace the room extension pump relay.

**If the 20 AMP fuse in the 6101 wire is not blown**, check terminals A and C for +12 power while pushing a room control switch. If there is power on terminals A and C, there is a problem with the connection at terminal C. Remember, if the pump runs for the leveling system, it will run for the room extensions.

**If there is power on terminal A**, but not C while pushing a room control switch, the room extension pump relay is bad and should be replaced.

**If there is no power on terminal A**, find the connection for the HWH room extension pump/manifold harness to the Winnebago room control harness. Check for +12 power on the 6101 wire (CCY) at the connection. If power is not present, there is a problem between the connection and the room pump relay on the 6101 wire. If there is +12 power on the 6101 (CCY) wire at the connection, check for power on the 8602 (DDA) wire, front room and the 8601 (DDK) wire, rear room while pushing the room control switches. If there is power on either wire, there is a problem on that wire between the connection and terminal A at the pump relay.

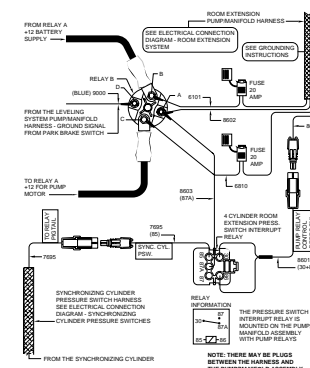

**REFER TO MP85.322Q  
(310 LEVELING SYSTEM)**

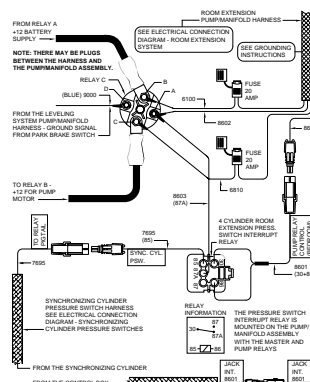

**MP85.504M  
(610 LEVELING SYSTEM)**

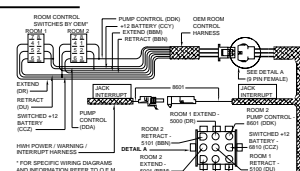

**REFER TO MP85.321C  
OR MP85.321J  
(310 LEVELING SYSTEM)  
MP85.504F  
OR MP85.504H  
(610 LEVELING SYSTEM)**

# TROUBLE SHOOTING

PROBLEM	SOLUTION	FIGURES
<p><b>Part 1 Continued</b></p>	<p>If there is no power at the connection on the 8601 (DDK) wire or the 8602 (DDA) wire while pushing a room control switch, remove the room control switches. Check for +12 power at pin 2 of the switches. If power is not present, the problem is with the CCY wire or connections for the CCY wire. If there is power on pin 2 of the room control switch, check pin 1 while pushing the switch to EXTEND and pin 3 while pushing the switch to RETRACT. If power is not present on either pin, replace the switch. If power is present on pins 1 and 3 the problem is the Winnebago DDA wire (front room), the Winnebago DDK wire (rear room), the Winnebago connection to the HWH harness, the HWH 8602 wire (front room), the HWH 8601 wire (rear room), the pressure switch interrupt relay on the pump for the rear room or the 8603 wire from the interrupt relay to the room extension pump relay.</p>	<p style="text-align: center;"><b>REFER TO MP85.321C OR MP85.321J (310 LEVELING SYSTEM) MP85.504F OR MP85.504H (610 LEVELING SYSTEM)</b></p>
<p><b>Part 2 The rear room operates fine but the front room does not work. The pump does not run.</b></p>	<p>Remove the control switch for the front room. Check for +12 volt power on pin 2 of the switch. If power is not present, the problem is with the Winnebago CCY wire.</p> <p><b>Note:</b> The CCY wire provides +12 power to operate the pump for all room control switches.</p> <p>If +12 power is present on pin 2, check pins 1 and 3 for power while pushing the switch to EXTEND or RETRACT. If power is not present replace the switch. If power is present, the problem is the Winnebago DDA wire, the HWH 8602 wire, connections for these wires or the connection for the 8602 wire at terminal A of the room extension pump relay.</p>	<p style="text-align: center;"><b>REFER TO MP85.321C OR MP85.321J (310 LEVELING SYSTEM) MP85.504F OR MP85.504H (610 LEVELING SYSTEM)</b></p> <p style="text-align: center;"><b>REFER TO MP85.322Q (310 LEVELING SYSTEM) OR MP85.504M (610 LEVELING SYSTEM)</b></p>
<p><b>Part 3 The front room operates fine but the rear room does not work. The pump does not run.</b></p>	<p><b>Important:</b> During these tests DO NOT attempt to run the FOUR CYLINDER room extension with the synchronizing cylinder pressure switches unplugged.</p> <p>The synchronizing cylinder for the four cylinder room extension is equipped with four pressure switches, one for each room cylinder. Early systems have a two wire pressure switch set at 4000 PSI. Later model systems have a one wire switch set at 5000 PSI. These switches are normally open switches. They complete a ground circuit when closed under high pressure. The pressure switches protect the system from damage if one or more cylinders malfunction while the room is operating. If a cylinder or corner of the room stops moving before the room is fully extended or retracted, pressure between the synchronizing cylinder and the rod end of the room cylinder can become extremely high.</p> <p>If the front room is retracted, push the front room control switch to EXTEND briefly. If the front room is extended, push the front room control switch to RETRACT briefly. This should relieve pressure on the four cylinder synchronizing cylinder. Try the rear room. If the pump now runs, a pressure switch was closed.</p> <p>There are two pressure reducing valves on the sync. cylinder. The rod end of the upper two room cylinders must be connected to these valves. Also the valves must be in the center two outlets of the sync. cylinder. If the valves need to be moved, make sure the upper cylinders are connected to the pressure reducing valves.</p>	<p style="text-align: center;"><b>REFER TO MP85.324C (310 LEVELING SYSTEM) OR MP85.505G (610 LEVELING SYSTEM)</b></p>

# TROUBLE SHOOTING

## PROBLEM

## SOLUTION

## FIGURES

### Part 3 Continued

If the pressure reducing valves do not need to be moved or moving the valves does not help, check room adjustments make sure a corner of the room is not dragging or catching on something. Retract the room to within two or three inches of being fully retracted. Loosen the room out adjustment nut several turns. Bump the room out and back in several inches. Tighten the room out adjustment nut. Check the height adjustment of the room. Refer to Winnebago for proper adjustment procedures.

If room adjustments are OK, check the sync. cylinder pressure switches. If two wire switches are used, replace all four switches with the 5000 PSI single wire switches. If the system has one wire switches or the problem continues after replacing the pressure switches, check the room extension hydraulic manifold. If the manifold has solenoid valves with a diameter of 1 1/2 inches change the complete manifold to a manifold with the large solenoid valves.

If the system has the large solenoid valves or the problem continues. Check each sync. cylinder pressure switch to see which switch is closed. (Check for continuity between the pressure switch wire connected to harness wire 7695 and ground.) Change the room cylinder for the switch that is closed. Refer to MP45.946A.

If changing the cylinder does not fix the problem, replace the sync. cylinder. Refer to MP45.9953.

**NOTE:** When replacing the four cylinder sync. cylinder on a Class A motor home, a sync. cylinder with 5000 PSI pressure switches must be used.

**If the pump will still not run with the pressure reduced on the sync. cylinder,** it is an electrical problem in the system. If the front room is operating properly, the pump and pump relays are OK. The problem is in the wiring harness for the rear room.

Check each sync. cylinder pressure switch. Replace any switch that is closed. (Shows continuity to ground.)

If the pressure switches are OK, check terminal 85, the 7695 wire, of the pressure switch interrupt relay for ground. If a ground is present, the 7695 wire is shorted to ground.

If there is no ground on terminal 85, check the 8603 wire at terminal A for +12 volts while pushing the rear room control switch to EXTEND or RETRACT. If +12 volts is present, there may be a connection problem at terminal A.

If there is no power on the 8603 wire, check for +12 on terminal 87A and the 8601 wire to terminal 86 of the pressure switch interrupt relay while pushing the room control switch. If power is present at terminal 87A, the 8603 wire has a problem. If there is power to terminal 86 but not 87A, the interrupt relay is bad.

If there is no power on the 8601 wire at terminal 86, remove the rear room control switch and check terminals 1 and 3 of the switch while pushing the switch. If power is present, there is a problem on the Winnebago DDK wire, the HWH 8601 wire or connections between these wires. Refer to Winnebago wiring diagrams.

If there is no power on terminals 1 and 3, check terminal 2 for +12. (Switch does not have to be pushed.) If power is present, the switch is bad. If power is not present there is a problem with the Winnebago CCY wire. This wire also supplies power for the front room switch.

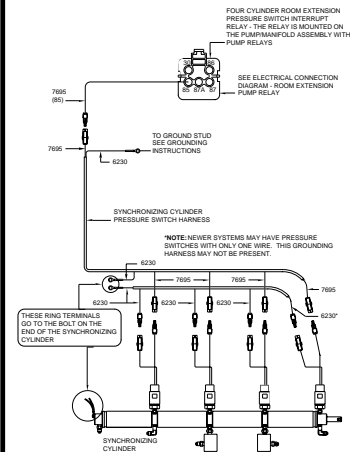

**REFER TO MP85.324C  
(310 LEVELING SYSTEM)  
OR  
MP85.505G  
(610 LEVELING SYSTEM)**

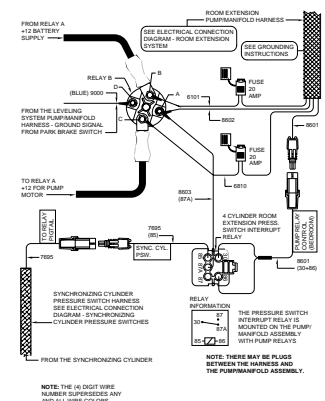

**REFER TO MP85.322Q  
(310 LEVELING SYSTEM)  
OR  
MP85.504M  
(610 LEVELING SYSTEM)**

**MI91.231G  
19DEC00**

# TROUBLE SHOOTING

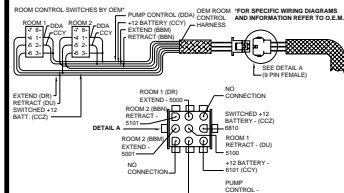
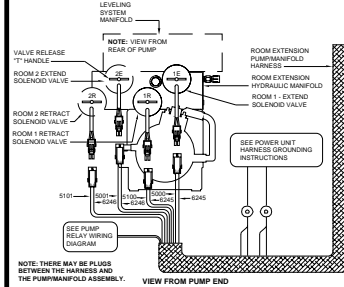
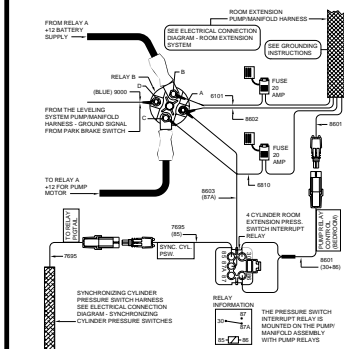
PROBLEM	SOLUTION	FIGURES
<p><b>Part 4</b>  <b>The pump runs when a room control switch is pushed to EXTEND but not RETRACT OR when a switch is pushed to RETRACT but not EXTEND.</b></p>	<p>Remove the switch that is not functioning properly. Check the connection of the DDA wires to pins 1 and 3 of the switch. If power is present on both pins while pushing the switch to EXTEND and RETRACT, the problem is the DDA wire or DDA wire connections. If power is not present, replace the room control switch.</p>	 <p style="text-align: center;"><b>REFER TO MP85.321C  OR MP85.321J  (310 LEVELING SYSTEM)  MP85.504F  OR MP85.504H  (610 LEVELING SYSTEM)</b></p>
<p><b>Part 5</b>  <b>A room will not extend or retract. The pump runs but does not build pressure.</b></p>	<p>Check the operation of the leveling system. A faulty shuttle valve or low pump pressure will cause a problem for the room extension(s).</p> <p>Make sure all valve release "T" handles (large valves) and/or valve release nuts (small valves) are closed (turn clockwise). With the room(s) and jacks fully retracted, check the fluid level in the tank. It should be within 1 inch of the top.</p> <p>If the leveling system is working properly, continue.</p> <p><b>If trying to EXTEND</b>, the retract valve is open. Unplug the retract valve. If the problem stops, the problem is probably the room control switch. If the problem continues, replace the retract valve.</p> <p><b>If trying to RETRACT</b>, the extend valve is open. Unplug the extend valve. If the problem stops, the problem is probably the room control switch. If the problem continues, replace the extend valve.</p>	 <p style="text-align: center;"><b>REFER TO MP85.321C  OR MP85.321J  (310 LEVELING SYSTEM)  MP85.504F  OR MP85.504H  (610 LEVELING SYSTEM)</b></p>
<p><b>Part 6</b>  <b>The pump runs but the room will not extend or retract. The pump seems to be dead heading.</b></p>	<p>There is no power to the room control switch to operate the solenoid valves unless the pump is running. If the room will extend but not retract or will retract but not extend, there is power to the room control switch. The problem is between the room control switch and the solenoid valves. Start troubleshooting at "<b>There is power to terminal 5 of the room control switch.</b>" If the room will neither EXTEND or RETRACT, continue with the next paragraph.</p> <p>Check terminal 5 of the room control switch for 12 volts while pushing the switch to extend or retract. With the pump motor running there should be +12 volts at terminal 5.</p> <p><b>There is no power at terminal 5 of the room control switch.</b> Check the 20 amp fuse in the 6810 wire at the room extension pump relay. <b>If the fuse is OK</b>, the problem is the connection at terminal C of the relay, a problem with the HWH 6810 wire, a problem with the connection of the HWH harness to the Winnebago harness or a problem with the Winnebago CCZ wire or connections in the Winnebago harness. With the pump running, start at the pump relays checking at each connection until the problem is isolated. <b>If the fuse is blown</b>, replace the fuse and push the room control switch to EXTEND. If the fuse blows again, the problem is the EXTEND valve, a short in the HWH 5000 (or 5001) wire, a short in the Winnebago DR (or BBM) wire, the CCZ wire or the 6810 wire. If the fuse does not blow, push the switch to RETRACT. If the fuse blows, the problem is the retract valve, a short in the HWH 5100 (or 5101) wire, or a short in the Winnebago DU (or BBN) wire.</p>	 <p style="text-align: center;"><b>REFER TO MP85.322Q  (310 LEVELING SYSTEM)  MP85.504M  (610 LEVELING SYSTEM)</b></p>

# TROUBLE SHOOTING

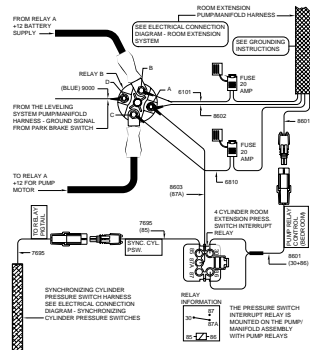
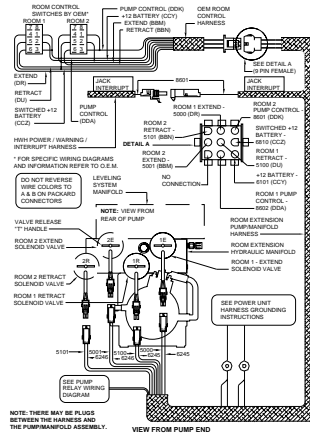
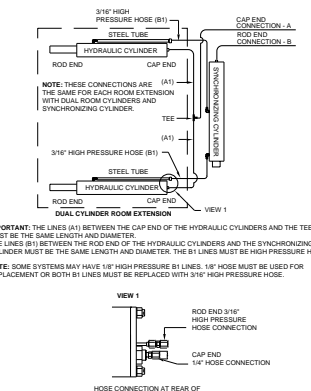
PROBLEM	SOLUTION	FIGURES
<p><b>Part 6</b> <b>Continued</b></p>	<p>If the coach is equipped with two rooms and the 20 amp fuse in the 6810 wire blows when either room is operated the problem is probably a short in the Winnebago CCZ wire on the HWH 6810 wire.</p> <p><b>There is power to terminal 5 of the room control switch.</b> The problem is the room control switch, the harness wires, the ground connections for the solenoid valves or the solenoid valve itself.</p> <p><b>If the room will not extend,</b> check terminal 4 of the room control switch while pushing the switch to extend. If +12 volts is not present, replace the switch. If +12 volts is present, unplug the extend solenoid valve and check for +12 volts between the A&amp;B pins of the harness plug, while pushing the switch to extend. If +12 is present, replace the extend solenoid valve. If +12 is not present, check from pin B in the plug to a good frame ground, while pushing the switch to extend. If +12 is present, the problem is the ground wire or pin A for the EXTEND valve. If +12 is not present, the problem is the HWH 5000 (or 5001) wire, the Winnebago DR (or BBM) wire or harness connections between the room switch and the EXTEND valve.</p> <p><b>If the room will not retract,</b> check terminal 6 of the room control switch while pushing the switch to RETRACT. If +12 volts is not present, replace the switch. If +12 volts is present, unplug the retract solenoid valve and check for +12 between the A&amp;B pins of the harness plug while pushing the switch to RETRACT. If +12 is present, replace the retract solenoid valve. If +12 is not present, check between pin B of the harness plug and a good frame ground while pushing the switch to RETRACT. If +12 is present, the problem is the ground wire or pin A for the retract solenoid valve. If +12 is not present, the problem is the HWH 5100 (or 5101) wire, the Winnebago DU (or BBN) wire or harness connections between the room switch and the retract valve.</p>	 <p style="text-align: center;"><b>REFER TO MP85.322Q (310 LEVELING SYSTEM) MP85.504M (610 LEVELING SYSTEM)</b></p>  <p style="text-align: center;"><b>REFER TO MP85.321C OR MP85.321J (310 LEVELING SYSTEM) MP85.504F OR MP85.504H (610 LEVELING SYSTEM)</b></p>
<p><b>Part 7</b> <b>The room moves irrationally from side to side (walking/racking) as it extends or retracts.</b></p>	<p>The room extension mechanisms are designed to allow the room to extend and retract fully at both ends of the room. This allows the room to maintain a proper seal when extended or retracted. Some movement of the room is allowable. Excessive racking is usually caused by the room binding on some obstruction. Check fore and aft adjustments of the room. The room may be binding on carpets, side walls ceilings or room seals. Improper height adjustments can cause the room mechanisms to bind. Awnings can cause the room to rack excessively. Air in the system can cause racking, especially after repairs. Make sure room extension tubes or cylinders are not covered with grease, paint or undercoating.</p>	 <p style="text-align: center;"><b>REFER TO MP65.302K</b></p>

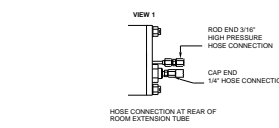
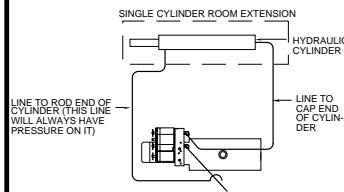

# TROUBLE SHOOTING

PROBLEM	SOLUTION	FIGURES
<p><b>Part 7</b> <b>Continued</b></p>	<p><b>DUAL CYLINDER ROOMS WITH SYNCHRONIZING CYLINDER.</b> Improper hose lengths can cause racking. Hoses between the sync. cylinder and the rod end of the room cylinders must be the same length and diameter high pressure hose. Hoses from the cap end of the room cylinders and where they tee together must be the same length and diameter. They do not have to be high pressure hose. Cap end and rod end hoses do not have to be the same.</p> <p><b>FOUR CYLINDER WITH SYNCHRONIZING CYLINDER.</b> Improper hose lengths can cause racking. Hoses between the upper and lower cylinders are different. Refer to MP65.390Q for correct hose information.</p>	<p><small>IMPORTANT: THE LINES (A1) BETWEEN THE CAP END OF THE HYDRAULIC CYLINDERS AND THE TEE MUST BE THE SAME LENGTH AND DIAMETER. THE LINES (B1) BETWEEN THE ROD END OF THE HYDRAULIC CYLINDERS AND THE SYNCHRONIZING CYLINDER MUST BE THE SAME LENGTH AND DIAMETER. THE B1 LINES MUST BE HIGH PRESSURE HOSE.</small></p> <p><small>NOTE: SOME SYSTEMS MAY HAVE 1/2" HIGH PRESSURE B1 LINES. 1/2" HOSE MUST BE USED FOR REPLACEMENT OR BOTH B1 LINES MUST BE REPLACED WITH 3/4" HIGH PRESSURE HOSE.</small></p>  <p style="text-align: center;"><b>REFER TO MP65.302K</b></p> <p><small>IMPORTANT: THE TWO LINES BETWEEN THE CAP END OF THE LOWER CYLINDERS AND THE TEE ASSEMBLY MUST BE THE SAME LENGTH AND DIAMETER. THE TWO LINES BETWEEN THE ROD END OF THE LOWER CYLINDERS AND THE SYNCHRONIZING CYLINDER MUST BE HIGH PRESSURE HOSE THAT IS THE SAME LENGTH AND DIAMETER. THE TWO LINES BETWEEN THE CAP END OF THE UPPER CYLINDERS AND THE TEE ASSEMBLY MUST BE THE SAME LENGTH AND DIAMETER. THE TWO LINES BETWEEN THE ROD END OF THE UPPER CYLINDERS AND THE SYNCHRONIZING CYLINDER MUST BE HIGH PRESSURE HOSE THAT IS THE SAME LENGTH AND DIAMETER.</small></p> <p><small>NOTE: THE PRESSURE REDUCING VALVES MAY BE IN A DIFFERENT POSITION ON THE SYNCHRONIZING CYLINDERS. THEY WILL ALWAYS CONNECT TO THE ROD END OF THE UPPER CYLINDERS.</small></p> <p style="text-align: center;"><b>REFER TO MP65.390Q</b></p>
	<p>If the room is not binding anywhere and the hose lengths are OK, replace the synchronizing cylinder.</p>	<p style="text-align: center;"><b>REFER TO MP45.9953</b></p>
<p><b>Part 8</b> <b>The ends of the room do not move at an equal distance from the vehicle.</b></p>	<p>The system is designed to run unsynchronized for approximately 1 inch at the end of the travel of the room when extending or retracting. This allows the room to seal properly when extended or retracted at the front and rear of the room. As long as the room does not rack excessively and seals properly front and rear when fully extended or retracted, there is no problem and no adjustments that will change this. If the room seems to catching, check up and down adjustments also fore and aft adjustments.</p>	
<p><b>Part 9</b> <b>The room creeps out after being retracted.</b></p>	<p>The following deals with either single or dual cylinder room extensions. There are three possibilities:</p> <ul style="list-style-type: none"> <li>A. An extend solenoid valve is leaking.</li> <li>B. A room extension cylinder has an internal leak.</li> <li>C. The manifold check valve is leaking.</li> </ul> <p><b>NOTE :</b> If the room creeps out 1 or 2 inches or less the problem is most likely the check valve.</p> <p>Retract the room completely. Remove the hydraulic line for the cap end of the cylinder at the manifold. Hold the line with the hose end in an upright position. Press the rocker switch for that room to the <b>RETRACT</b> position.</p>	 <p style="text-align: center;"><b>REFER TO MP65.390F OR MP65.390H</b></p>
	<p>If fluid flows from the manifold fitting, the extend solenoid valve needs to be changed.</p>	<p style="text-align: center;"><b>REFER TO MP65.390F OR REFER TO MP65.390H</b></p>

# TROUBLE SHOOTING

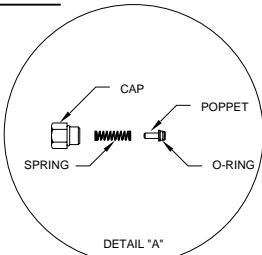
PROBLEM	SOLUTION	FIGURES
<b>Part 9 Continued</b>	If fluid flows from the hose end, the room extension cylinder should be replaced.	 <p style="text-align: center;"><b>REFER TO MP65.390F OR MP65.390H</b></p>
	If no fluid flows from either the hose end or the manifold fittings, inspect the manifold check valve. There is a spring below the cap. DO NOT lose the spring. Check for cuts on the poppet o-ring. Check the poppet and cap for burrs. The poppet should easily slide in the cap. If the check valve is OK, the problem is most likely the solenoid valve. Support the cap end hose with the hose end up. Allow the system to sit for several hours. Check and see if fluid is seeping from hose or the manifold fitting.	
	To replace a four cylinder room extension cylinder, see MP45.946A.	
	To replace a dual cylinder room extension cylinder, see MP45.9435.	
	To replace a "FLAT FLOOR" room ext. cylinder, see MP45.947A	
<b>Part 10 The room creeps back in after being extended.</b>	Replace the retract solenoid valve for that room extension. This is the only possibility that would cause this problem.	<p style="text-align: center;"><b>REFER TO MP65.390F OR REFER TO MP65.390H</b></p>
<b>Part 11 The room does not seal tightly when fully extended or retracted.</b>	For four cylinder room extensions see MP45.946A.  For dual cylinder room extensions see MP45.9436.  For "FLAT FLOOR" dual cylinder room extensions see MP45.947D	
<b>Part 12 "FLAT FLOOR" ONLY. The room will not drop to the flat position as it extends.</b>	The problem is probably the "FLIPPERS" in the "FLAT FLOOR" mechanism. This is a complicated repair. Contact HWH Customer Service before attempting to make this repair.	

# MANUAL ROOM RETRACT PROCEDURE (WITH SOLENOID VALVES WITH VALVE RELEASE "T" HANDLES)

(USE ONLY WHEN THE ROOM WILL NOT RETRACT WITH THE ROOM CONTROL SWITCH)

## OVERVIEW

The room can be retracted manually if a hydraulic or electric failure prevents the room from being retracted using the CONTROL SWITCH. For normal retract sequence see the ROOM SLIDE RETRACT PROCEDURES. Refer to the vehicle manufacturer for storage location of the retract device and information for connecting the device to the room.

**IMPORTANT:** If the vehicle is not equipped with a winch, DO NOT use other pulling devices to retract the room. Follow steps 2 and 3 and try pushing the room in. Contact the vehicle manufacturer or HWH Customer Service at 1-800-321-3494 or 563-724-3396 for assistance.

**WARNING:** THE MANUAL RETRACT WINCH IS EQUIPPED FOR MANUALLY RETRACTING THE ROOM ONLY. IT IS NOT TO BE USED FOR LIFTING OR ANY OTHER APPLICATION. HIGH FORCES ARE CREATED WHEN USING A WINCH, CREATING POTENTIAL SAFETY HAZARDS. FAILURE TO FOLLOW ALL CAUTIONS AND INSTRUCTIONS MAY CAUSE FAILURE OF THE MANUAL RETRACT WINCH OR CONNECTIONS RESULTING IN DAMAGE OR PERSONAL INJURY. MAINTAIN FIRM GRIP ON THE WINCH HANDLE AT ALL TIMES. NEVER RELEASE THE HANDLE WHEN RATCHET LEVER IS IN THE OFF POSITION AND THE WINCH IS LOADED. THE WINCH HANDLE COULD SPIN VIOLENTLY AND CAUSE PERSONAL INJURY. CHECK THE WINCH AND STRAPS FOR DAMAGE OR WEAR, AND CHECK FOR PROPER RATCHET OPERATION ON EACH USE OF THE WINCH. DO NOT USE IF DAMAGED OR WORN.

1. Retract jacks following the LEVELING SYSTEM RETRACT PROCEDURE.

**NOTE :** When manually retracting the room, make sure the jacks are retracted before retracting the room.

2. Locate the HYDRAULIC PUMP/MANIFOLD unit.

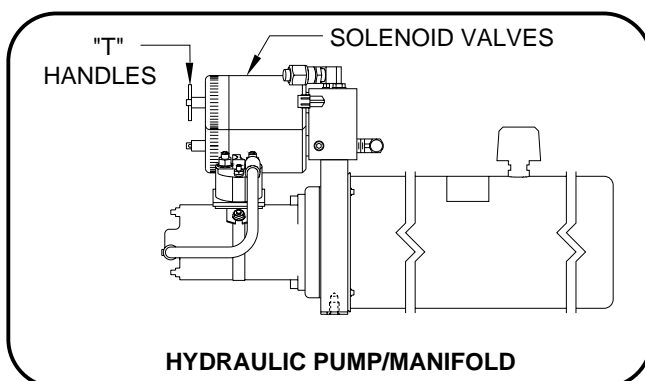

3. Open the SOLENOID VALVES by turning the "T" HANDLES counterclockwise.

**NOTE :** The "T" HANDLE may turn easily at first but will become more difficult to turn as an internal spring is compressed. Be sure to open both valves completely (about six turns of the "T" HANDLE).

**NOTE :** The room may move slightly as the SOLENOID VALVES are opened and internal pressure is released.

4. Locate the MANUAL RETRACT WINCH and connect it to the room according to the vehicle manufacturer's instructions. To extend the WINCH STRAP firmly grasp WINCH HANDLE, place RATCHET LEVER in its OFF position, and slowly rotate the WINCH HANDLE counterclockwise, keeping a firm grip on the handle. When enough WINCH STRAP is extended, place the RATCHET LEVER in its ON position and slowly rotate the WINCH HANDLE clockwise until the RATCHET LEVER locks.

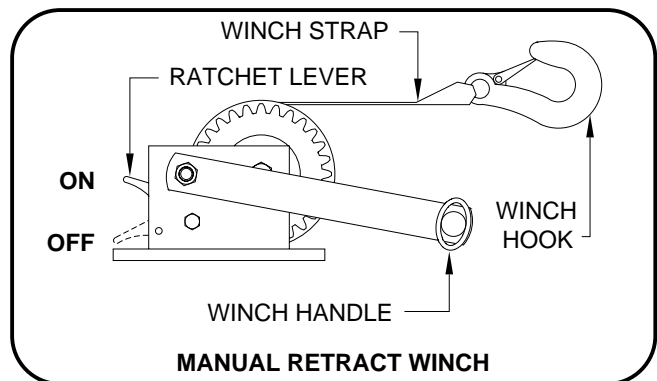

5. Slowly winch the room in by turning the WINCH HANDLE clockwise. The RATCHET LEVER should produce a loud, sharp, clicking noise.

**NOTE :** Winching the room in quickly will raise pressure in the hydraulic fluid and make winching more difficult.

**WARNING:** OPERATE THE MANUAL RETRACT WINCH BY HAND POWER ONLY. IF THE WINCH CANNOT BE CRANKED EASILY WITH ONE HAND IT IS PROBABLY OVER-LOADED. IF WINCHING BECOMES TOO DIFFICULT STOP AND CHECK FOR OBSTRUCTIONS OR RESTRICTIONS ON THE ROOM AND ROOM EXTENSION MECHANISM.

6. When the room is fully retracted, engage the room locking devices. Leave the retract winch in place.

**WARNING:** THE ROOM EXTENSION SOLENOID VALVE "T" HANDLES MUST BE IN THE OPEN POSITION WHEN THE MANUAL RETRACT WINCH IS ENGAGED.

7. The system should be repaired before using again.

# MANUAL ROOM AND GENERATOR SLIDE RETRACT PROCEDURE (WITH SOLENOID VALVES WITH VALVE RELEASE NUTS)

(USE ONLY WHEN THE ROOM WILL NOT RETRACT WITH THE ROOM CONTROL SWITCH)

## OVERVIEW

The room can be retracted manually if a hydraulic or electric failure prevents the room from being retracted using the CONTROL SWITCH. For normal retract sequence see the ROOM SLIDE RETRACT PROCEDURES. Refer to the vehicle manufacturer for storage location of the winch and information for connecting the winch to the room.

**IMPORTANT:** If the vehicle is not equipped with a winch, DO NOT use other pulling devices to retract the room. Follow steps 2 and 3 and try pushing the room in. Contact the vehicle manufacturer or HWH Customer Service at 1-800-321-3494 or 563-724-3396 for assistance.

**CAUTION:** THE MANUAL RETRACT WINCH IS EQUIPPED FOR MANUALLY RETRACTING THE ROOM ONLY. IT IS NOT TO BE USED FOR LIFTING OR ANY OTHER APPLICATION. HIGH FORCES ARE CREATED WHEN USING A WINCH, CREATING POTENTIAL SAFETY HAZARDS. FAILURE TO FOLLOW ALL CAUTIONS AND INSTRUCTIONS MAY CAUSE FAILURE OF THE MANUAL RETRACT WINCH OR CONNECTIONS RESULTING IN DAMAGE OR PERSONAL INJURY. MAINTAIN FIRM GRIP ON THE WINCH HANDLE AT ALL TIMES. NEVER RELEASE THE HANDLE WHEN RATCHET LEVER IS IN THE OFF POSITION AND THE WINCH IS LOADED. THE WINCH HANDLE COULD SPIN VIOLENTLY AND CAUSE PERSONAL INJURY. CHECK THE WINCH AND STRAPS FOR DAMAGE OR WEAR, AND CHECK FOR PROPER RATCHET OPERATION ON EACH USE OF THE WINCH. DO NOT USE IF DAMAGED OR WORN.

1. Retract jacks following the LEVELING SYSTEM RETRACT PROCEDURE.

**NOTE :** When manually retracting the room, make sure the jacks are retracted before retracting the room.

2. Locate the HYDRAULIC PUMP/MANIFOLD unit.

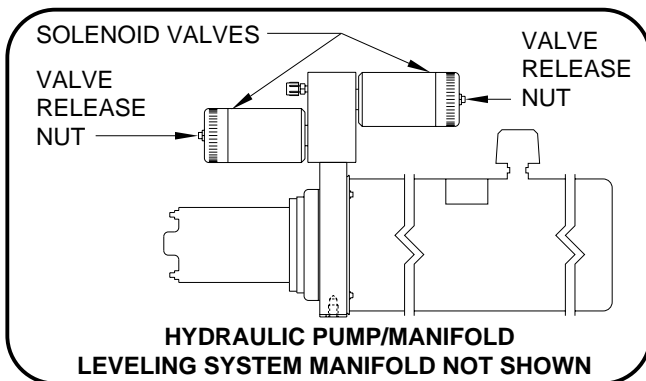

3. Open the Solenoid Valves by slowly turning the valve release nuts counter clockwise using the 1/4" nut driver supplied.

**IMPORTANT:** Only open the valves enough to retract the room. DO NOT turn the release nuts more than 4 and 1/2 turns. Turning the nuts more could damage the valves.

**NOTE:** Prior to APRIL 2002 a 1/4" Nut Driver was sent with the Operators Manual. As of APRIL 2002 the 1/4" Nut Driver has been incorporated into the Breather Cap. See the back page of this manual for further info.

**NOTE:** The room may move slightly as the SOLENOID VALVES are opened and internal pressure is released.

4. Locate the MANUAL RETRACT WINCH and connect it to the room according to the vehicle manufacturer's instructions. To extend the WINCH STRAP firmly grasp WINCH HANDLE, place RATCHET LEVER in its OFF position, and slowly rotate the WINCH HANDLE counter clockwise, keeping a firm grip on the handle. When enough WINCH STRAP is extended, place the RATCHET LEVER in its ON position and slowly rotate the WINCH HANDLE clockwise until the RATCHET LEVER locks.

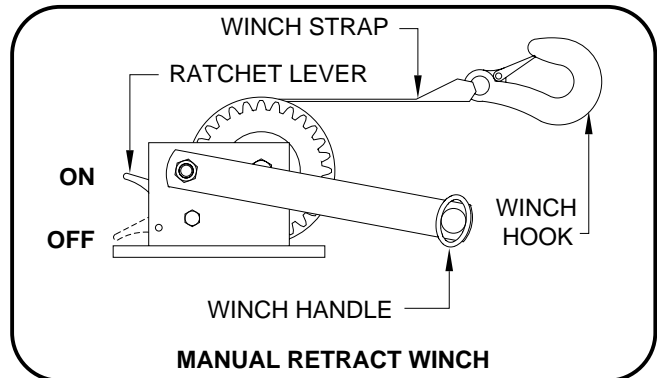

5. Slowly winch the room in by turning the WINCH HANDLE clockwise. The RATCHET LEVER should produce a loud, sharp, clicking noise.

**NOTE:** Winching the room in quickly will raise pressure in the hydraulic fluid and make winching more difficult.

**CAUTION:** OPERATE THE MANUAL RETRACT WINCH BY HAND POWER ONLY. IF THE WINCH CANNOT BE CRANKED EASILY WITH ONE HAND IT IS PROBABLY OVERLOADED. IF WINCHING BECOMES TOO DIFFICULT STOP AND CHECK FOR OBSTRUCTIONS OR RESTRICTIONS ON THE ROOM AND ROOM EXTENSION MECHANISM.

6. When the room is fully retracted, engage the room locking devices. Leave the retract winch engaged and the solenoid valves open.

**CAUTION:** THE ROOM EXTENSION SOLENOID VALVE RELEASE NUTS MUST BE IN THE OPEN POSITION WHEN THE MANUAL RETRACT WINCH IS ENGAGED.

7. The system should be repaired before using again.

**NOTE:** After repairs are made, when closing the VALVE RELEASE NUTS, do not over tighten the nuts.

MP35.952D  
01MAY02

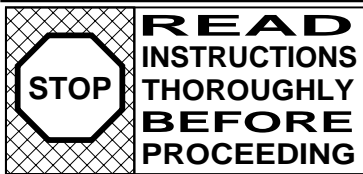

## ROOM EXTENSION CYLINDER REPLACEMENT DUAL CYLINDER ROOM EXTENSION (WITH SYNCHRONIZING CYLINDER)

**IMPORTANT:** The following instructions must be followed or air lock of the synchronizing cylinder and unsynchronized operation of the room cylinders may result causing damage to the room. Please read the instructions before replacing the cylinder. **DO NOT** reverse direction of the room unless the room is fully extended or retracted.

1. Extend the room fully. There is an access hole on the inner sliding tube to access the cylinder rod mounting nuts. If the room cannot be fully extended the inner sliding tube access hole must be extended far enough to access the cylinder rod mounting nuts.

2. Loosen the extend valve "T" Handle/Valve release nut.

3. Loosen the retract valve "T" Handle/Valve release nut.

4. Remove the two nuts and washers from the cylinder cap end mounting plate for both the front and rear room cylinders.

**IMPORTANT:** Steps 4 and 5 must be done to protect the room from being damaged while bleeding air from and synchronizing the the room cylinders.

5. Remove the cylinder rod outer out stop adjusting nut for both the front and rear room cylinders.

6. Remove and cap the hoses at the end of the cylinder that is to be replaced.

7. Remove the cylinder that is to be replaced from the room extension tube.

**NOTE: Do not remove the caps from the new cylinder hose connections until you are ready to reattach the hoses. Save the caps.**

8. Remove the cylinder cap end mounting plate from the old cylinder and attach it to the new cylinder.

9. Install the inner out stop adjusting nut and lock washer completely onto the threaded rod of the new cylinder.

**IMPORTANT: DO NOT PULL THE CYLINDER ROD OUT OF THE NEW CYLINDER. INSTALL THE NEW CYLINDER WITH THE ROD RETRACTED AS IT WAS SHIPPED.**

**IMPORTANT: BEFORE INSTALLING THE NEW CYLINDER, CLEAN ALL EXCESS OIL FROM THE ROOM EXTENSION TUBE. SWAB THE TUBE THOROUGHLY WITH A MILD SOLVENT AND RAGS. EXCESS OIL LEFT IN THE TUBE MAY LEAK OUT GIVING THE APPEARANCE OF A LEAKY CYLINDER OR HOSE CONNECTION.**

10. Install the new cylinder in the room extension tube. **DO NOT** install the two cylinder cap end mounting plate nuts and washers.

11. Attach the hoses to the cylinder. Do not over tighten the hose ends. See MP45.9436 for tightening of hoses.

12. Remove Hose A from the room extension manifold. Use a cap from the new cylinder to cap the fitting in the manifold. Direct Hose A into the fluid reservoir.

13. Close the extend & retract valve "T" handles/Valve release nuts.

14. Push and hold the room control switch to "EXTEND" until the new cylinder is fully extended plus five seconds.

**NOTE:** The cap end of the cylinder will push the cylinder cap end mounting plate off the room extension tube. This is ok.

15. Reattach Hose A to the room extension manifold.

16. Push and hold the room control switch to "RETRACT" until both cylinders are fully retracted, plus 5 seconds. Extend and retract the cylinders at least twice or until they are running fully synchronized. **DO NOT** reconnect the cylinders until they are running fully synchronized.

**CAUTION: DO NOT TRY TO LINE THE ROOM CYLINDER ROD UP WITH THE MOUNTING HOLE WHILE THE ROD IS EXTENDING.**

17. Slide the cylinder rod thru the rod mounting plate hole on the inner sliding tube. Install the nuts and lock washers on the cylinder cap end mounting plate. Turn the cylinder rod inner adjusting nut into place and install the cylinder rod outer adjusting nut. Make the nut snug only, as a final adjustment will have to be made. Do this for the front and rear cylinders.

**IMPORTANT: Do not reverse direction of the room until the room is fully extended or retracted.**

18. Push the room control switch to retract and hold until the room is fully retracted plus 5 seconds. Watch for excessive racking of the room. Some racking can occur do to air in the system. If the room starts to bind up, release the room control switch immediately. If the room does not bind up, proceed to Step 20. If the room is bound up, go to Step 19.

19. If the room is bound up, repeat Steps 2, 3, 4 and 5. Manually push the room out to its full extension. Now repeat Steps 13, 16, 17 and 18. If the room will still not run properly, contact HWH CORPORATION Customer Service at (800)321-3494 or at (563)724-3396.

20. Extend the room fully again. Do not reverse direction until the room is fully extended. Repeat retracting and extending the room several times being careful not to reverse directions until the room is fully extended or retracted.

21. With the room fully extended, check seals for proper compression. If the seal is not compressed or needs more compression, loosen the cylinder rod outer adjusting nut and tighten the cylinder rod inner adjusting nut. If the seal is compressed too much, loosen the cylinder rod inner adjusting nut and tighten the cylinder rod outer adjusting nut.

22. Check all hose connections and mounting nuts and bolts for tightness and leaks.

# CYLINDER REPLACEMENT DUAL CYLINDER ROOM EXTENSION WITH SYNCHRONIZING CYLINDER

**NOTE:** ROD AND CAP END HOSE CONNECTIONS WILL BE THE SAME FOR MULTIPLE ROOM EXTENSIONS.

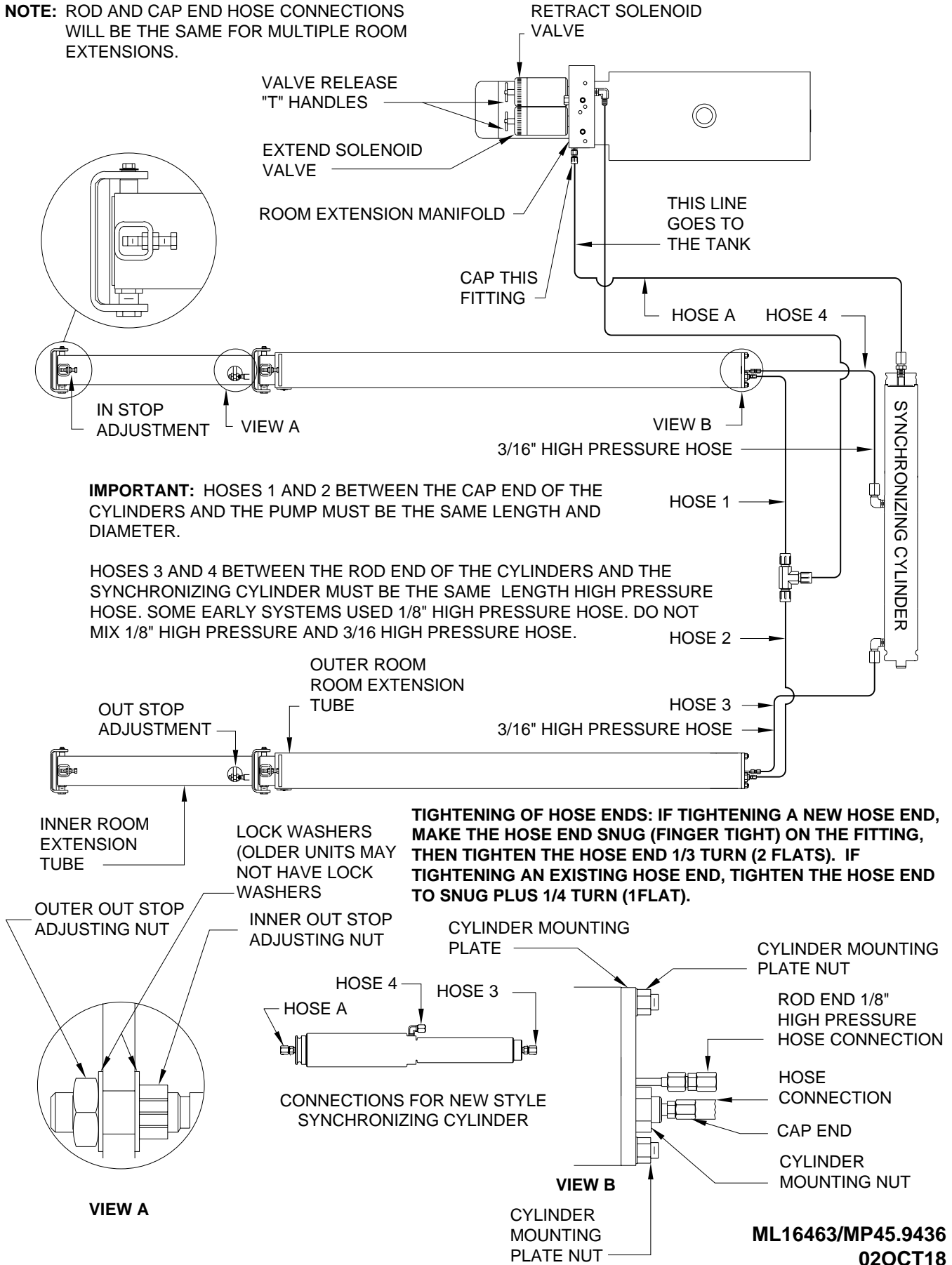

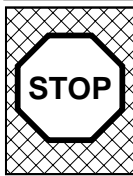

**READ  
INSTRUCTIONS  
THOROUGHLY  
BEFORE  
PROCEEDING**

## **CYLINDER REPLACEMENT/BLEEDING PROCEDURE FOUR CYLINDER ROOM EXTENSION WITH SYNCHRONIZING CYLINDER WITH ROOM EXTENSION MANIFOLD**

If a room cylinder is not being replaced but the room cylinders are not synchronized, follow Steps 1, 4, 5, and Steps 15 thru 18.

**IMPORTANT: The following instructions must be followed or air lock of the synchronizing cylinder and unsynchronized operation of the room cylinders may result causing damage to the room. Please read the instructions before replacing the cylinder. DO NOT reverse direction of the room unless the room is fully extended or retracted.**

**NOTE:** Do not remove the caps from the new cylinder hose connections until you are ready to reattach the hoses. Save the caps.

1. Extend the room fully. Support the outer edge of the room so that the room cannot sag when the room cylinder rods are disconnected. If the room will not extend, disconnect the room cylinder rods from the room and manually pull the room out to it's full extension and support the room.

2. Loosen the extend valve "T" handle/Valve release nut.

3. Loosen the retract valve "T" handle/Valve release nut.

4. Remove coach equipment and panels as necessary to gain access to all four room cylinders. Protect the coach interior from possible oil spillage.

5. Remove the outer out stop adjustment nut from each cylinder.

**IMPORTANT:** Step 5 must be done to protect the room from being damaged while bleeding air from and synchronizing the room cylinders.

6. Remove and cap the hoses from the rod and cap end of the cylinder that is to be replaced. Cap the cylinder fittings.

7. Remove the three cylinder mounting bolts.

8. Remove the cylinder from the vehicle.

**IMPORTANT: DO NOT PULL THE CYLINDER ROD OUT OF THE NEW CYLINDER. INSTALL THE CYLINDER WITH THE ROD RETRACTED AS IT WAS SHIPPED.**

9. Install the inner out stop adjustment nut from the old cylinder onto the new cylinder rod as far as it will go.

10. Install the new cylinder and attach it to the vehicle with the three mounting bolts. Do not pull the rod out of the cylinder.

11. Reattach the hoses to the correct fittings. Do not over tighten the fittings.

**Tightening of hose ends: If tightening a new hose end, make the hose end snug (finger tight) on the fitting, then tighten the hose end 1/3 turn (2 FLATS). If tightening an existing hose end, tighten the hose end to snug plus 1/4 turn (1 FLAT).**

12. Remove hose A from the manifold. Remove the breather cap and direct hose A into the tank. Cap fitting A with a steel cap from the replacement cylinder.

13. Close the extend and retract valve "T" handles/Valve release nuts.

14. Push and hold the room control switch to "EXTEND" until the new cylinder is fully extended plus 3 to 5 seconds. Watch carefully that the cylinder does not extend too far.

15. Reattach hose A to fitting A.

16. Push and hold the room control switch to "RETRACT" until all four cylinders are fully retracted. The new cylinder may not retract until the other three cylinders are fully retracted.

17. Repeat extending and retracting the cylinders fully at least 3 more times or until the cylinders are completely synchronized. Do not go from "RETRACT" to "EXTEND" until the cylinders are fully retracted. Do not go from "EXTEND" to "RETRACT" until the cylinders are fully extended. Check that there are no leaks and that hose routings are ok.

18. Reattach all four cylinders to the room with the out stop adjustment nuts. Run the inner out stop adjustment nut on the new cylinder out to the room for the initial adjustment.

19. Retract the room watching carefully that the room does not bind up. If the room binds up, DO NOT try to extend the room. Remove the outer out stop adjustment nuts and manually push the room out and support it. Repeat Steps 16 thru 18. If the room will still not work properly, call HWH CORPORATION Customer Service at (800)321-3494 or at (563)724-3396.

20. If the room works properly, extend and retract the room several times. Watch carefully that the room does not extend too far or bind up. Check that the room seals are properly compressed with the room extended. If the room needs to extend more, loosen the outer out stop adjustment nut and turn the inner adjustment nut out until the room is seated properly. Tighten the outer adjustment nut. If the room is extended too far, loosen the inner outstop nut and tighten the outer adjustment nut until the room is seated properly. Tighten the inner adjustment nut.

21. Check again for leaks and hose routings. **Clean any oil spills.** Reinstall the vehicle interior.

# ROOM EXTENSION CYLINDER REPLACEMENT/BLEEDING PROCEDURE

## FOUR CYLINDER ROOM EXTENSION WITH SYNCHRONIZING CYLINDER WITH ROOM EXTENSION MANIFOLD

**NOTE:** ROD AND CAP END HOSE CONNECTIONS WILL BE THE SAME FOR MULTIPLE ROOM EXTENSIONS.

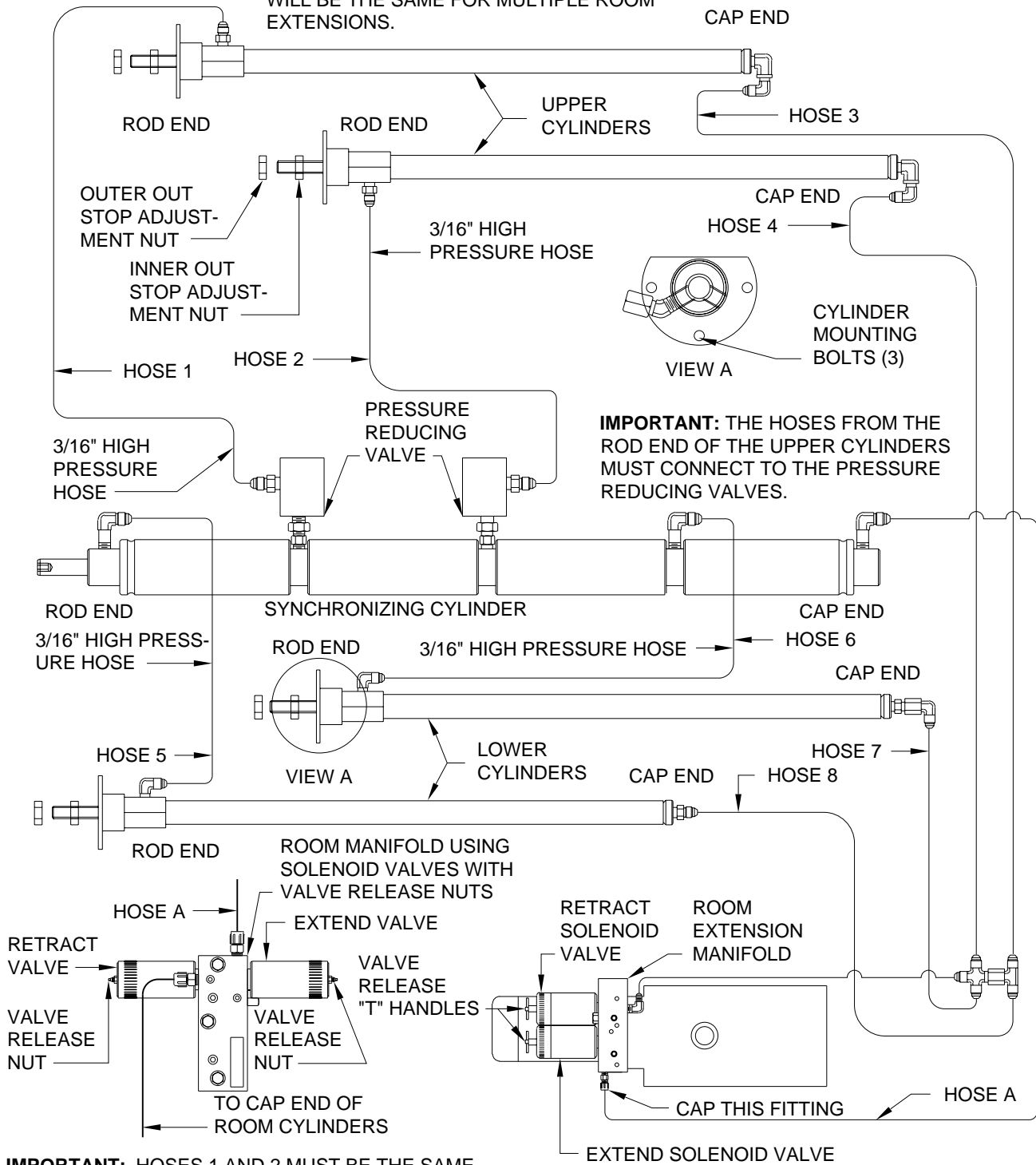

**IMPORTANT:** THE HOSES FROM THE ROD END OF THE UPPER CYLINDERS MUST CONNECT TO THE PRESSURE REDUCING VALVES.

**IMPORTANT:** HOSES 1 AND 2 MUST BE THE SAME LENGTH 3/16" HIGH PRESSURE HOSE. HOSES 5 AND 6 MUST BE THE SAME LENGTH 3/16" HIGH PRESSURE HOSE. SOME EARLY SYSTEMS USED 1/8" HIGH PRESSURE HOSE. DO NOT MIX 1/8" HIGH PRESSURE AND 3/16" HIGH PRESSURE HOSE.

HOSES 3 AND 4 MUST BE THE SAME LENGTH AND DIAMETER. HOSES 7 AND 8 MUST BE THE SAME LENGTH AND DIAMETER.

**NOTE:** THE PRESSURE REDUCING VALVES MAY BE IN A DIFFERENT POSITION ON THE SYNCHRONIZING CYLINDER. THEY WILL ALWAYS CONNECT TO THE ROD END OF THE UPPER CYLINDER.



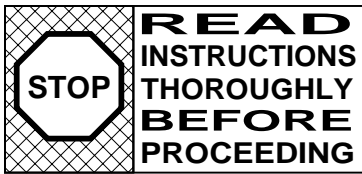

## ROOM EXTENSION CYLINDER REPLACEMENT DUAL CYLINDER FLAT FLOOR ROOM EXTENSION (WITH SYNCHRONIZING CYLINDER)

**IMPORTANT: The following instructions must be followed or air lock of the synchronizing cylinder and unsynchronized operation of the room cylinders may result causing damage to the room. Please read the instructions before replacing the cylinder. DO NOT reverse direction of the room unless the room is fully extended or retracted.**

1. Extend the room until the rod mounting pin is visible. Make sure the room is not starting to "LOWER". Support the room

**NOTE: Some rooms may need to be fully extended and supported to access the pin.**

2. Remove the mounting pin from both front and rear cylinders.

3. Push the room control switch to "EXTEND" until both cylinders are fully extended.

4. Open the extend valve "T" handle or valve release nut.

5. Open the retract valve "T" handle or valve release nut.

**NOTE: Valve release nuts should not be opened more than four (4) turns.**

6. Remove trunnion bolts (2) that mount the rear of the cylinder that is to be changed.

7. Mark the hoses so they are replaced in the correct position. Remove and cap the hoses from the cylinder connections.

8. Remove the cylinder. The cylinder may need to be lifted slightly so the rod eye does not catch on the STORE-MORE mounting that protrudes inside of the inner tube.

9. Measure the cap end cylinder mounting nut on the bad cylinder. Make sure the mounting nut is in the same position on the new cylinder.

10. Install the rod end hose from the old cylinder onto the new cylinder.

**Tightening of hose ends: If tightening a new hose end, make the hose end snug (finger tight) on the fitting, then tighten the hose end 1/3 turn (2 FLATS). If tightening an existing hose end, tighten the hose end to snug plus 1/4 turn (1 FLAT).**

11. Install the new cylinder. Support the cylinder so the rod eye does not catch the STORE-MORE mounting.

12. Install the trunnion bolts (2).

13. Attach the hoses to the new cylinder. DO NOT reverse hose connections.

14. Remove hose A from the room extension manifold. Use a steel cap from the new cylinder to cap the fitting in the manifold. Direct hose A into the fluid reservoir.

15. Close the "T" handles or valve release nuts.

**IMPORTANT: When extending or retracting the cylinders when the rod eye is not connected to the tube, the rod eye may catch on the STORE-MORE mounting. If necessary place a small block under both cylinders to raise the rod eye above the "STORE-MORE" mounting. Make sure it is not blocked so high it interferes with anything else in the tube. MOST OF ALL PAY ATTENTION.**

16. Push and hold the room control switch to "EXTEND" until the new cylinder is fully extended plus 5 seconds.

17. Open the extend valve then the retract valve "T" handles or valve release nuts.

18. Reattach hose A to the room extension manifold.

19. Close both valve "T" handles or valve release nuts.

20. Push and hold the room control switch to "RETRACT" until both cylinders are fully retracted plus five seconds. Repeat extending and retracting the cylinders AT LEAST 2 more times or until the cylinders are running fully synchronized.

21. Fully extend the cylinders then retract the cylinders so the hole in the rod eye and inner tube line up and install the pin and snap rings for both cylinders. It may be necessary to loosen the trunnion jam nuts to line up the mounting holes. Make sure the trunnion (cylinder mounting nut) is in the same position after tightening the jam nuts.

22. Push the room control switch to "RETRACT" and hold until the room is fully retracted plus 5 seconds. Watch for excessive racking of the room. Some racking can occur due to air in the system. If the room does not bind up, proceed to STEP 24. If the room is bound up proceed to STEP 23.

23. If the room is bound up and the rod eye pins are not visible, repeat STEP 6 for both cylinders and manually do STEP 1 then 2. Repeat STEPS 12 and 20 thru 22. If the room will still not run properly, contact HWH Customer Service 1-800-321-3494.

24. Extend the room fully again. DO NOT reverse direction until the room is fully extended. Repeat retracting and extending the room several times. DO NOT reverse directions until the room is fully extended or retracted.

25. Check and make room adjustments in this order: drop, extend and then retract.

# CYLINDER REPLACEMENT

## DUAL CYLINDER "FLAT FLOOR" ROOM EXTENSION WITH SYNCHRONIZING CYLINDER

**NOTE:** ROD AND CAP END HOSE CONNECTIONS WILL BE THE SAME FOR MULTIPLE ROOM EXTENSIONS.

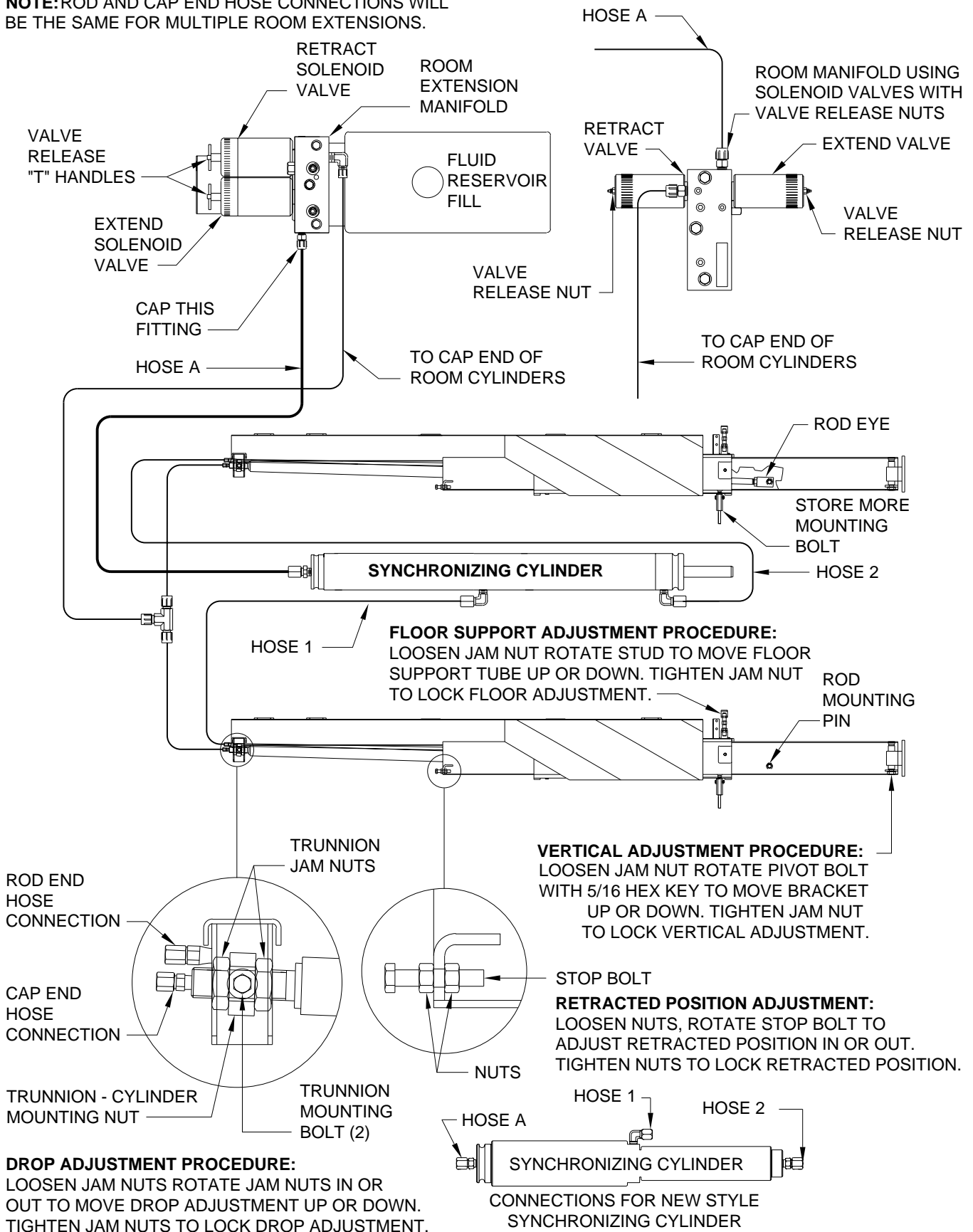



**READ  
INSTRUCTIONS  
THOROUGHLY  
BEFORE  
PROCEEDING**

## **SYNCHRONIZING CYLINDER OR HOSE ASSEMBLY REPLACEMENT ALL DUAL CYLINDER ROOM EXTENSIONS (WITH SYNCHRONIZING CYLINDER)**

**IMPORTANT:** The following instructions must be followed or air lock of the synchronizing cylinder and unsynchronized operation of the room cylinders may result causing damage to the room. Please read the instructions before replacing the cylinder. **DO NOT reverse direction of the room unless the room is fully extended or retracted.**

Refer to the correct room cylinder replacement sheet for information concerning room cylinder removal and replacement and any adjustments that need to be made.

1. Fully extend or retract the room according to the correct room cylinder replacement sheet.
2. Disconnect the end of both rods from the room extension mechanism.
3. Retract the rods completely.

**NOTE: Room cylinders must be fully retracted before replacing the synchronizing cylinder or hose assembly.**

4. Loosen the extend valve "T" handle.
5. Loosen the retract valve "T" handle.

**NOTE: If the system uses a reversible pump instead of a room manifold, open the one emergency retract valve.**

---

### **SYNCHRONIZING CYLINDER REPLACEMENT**

1. Remove and cap the hoses to the synchronizing cylinder.

**NOTE: DO NOT remove the caps from the new cylinder hose connections until you are ready to attach the hoses. Save the caps.**

2. Replace the synchronizing cylinder and reattach the hoses to the proper connections. **DO NOT** over tighten the hose connections.

**Tightening of hose ends: If tightening a new hose end, make the hose end snug (finger tight) on the fitting, then tighten the hose end 1/3 turn (2 FLATS). If tightening an existing hose end, tighten the hose end to snug plus 1/4 turn (1 FLAT).**

### **HOSE ASSEMBLY REPLACEMENT**

Remove and replace the hose assembly. Tighten the hose ends according to the above tightening procedure.

---

### **BLEEDING PROCEDURE**

1. Remove hose A from the room extension manifold. Use a cap from the new cylinder to cap the fittings in the manifold. Direct hose A into the fluid reservoir.
2. Close the extend and retract valve "T" handles/Valve release nuts. (The emergency retract valve if a reversible pump is used.)
3. Extend the rods completely. Hold the room control switch on for five seconds after the rods are fully extended.

Refer to the correct room cylinder replacement sheet to complete the bleed procedure. Start where the instructions reattach hose A to the pump assembly, or continue on this sheet.

4. Open the cylinder extend valve first, then the cylinder retract valve.
5. Reattach hose A to the manifold fitting and tighten. Close the solenoid valves.
6. Retract and extend the cylinders until they are running together. Cycle the cylinders at least three times, more if needed to synchronize the cylinders. Hold the switch about 5 seconds each time the cylinders are fully extended or retracted.
7. Reattach the cylinders to the room mechanism.
8. Extend and retract the room several times to make sure the room is synchronized. Watch the room closely and release the room switch immediately if the room starts to rack.

If the room will not synchronize, contact HWH for assistance.

# SYNCHRONIZING CYLINDER OR HOSE ASSEMBLY REPLACEMENT ALL TYPE A DUAL CYLINDER ROOM EXTENSIONS (WITH SYNCHRONIZING CYLINDER)

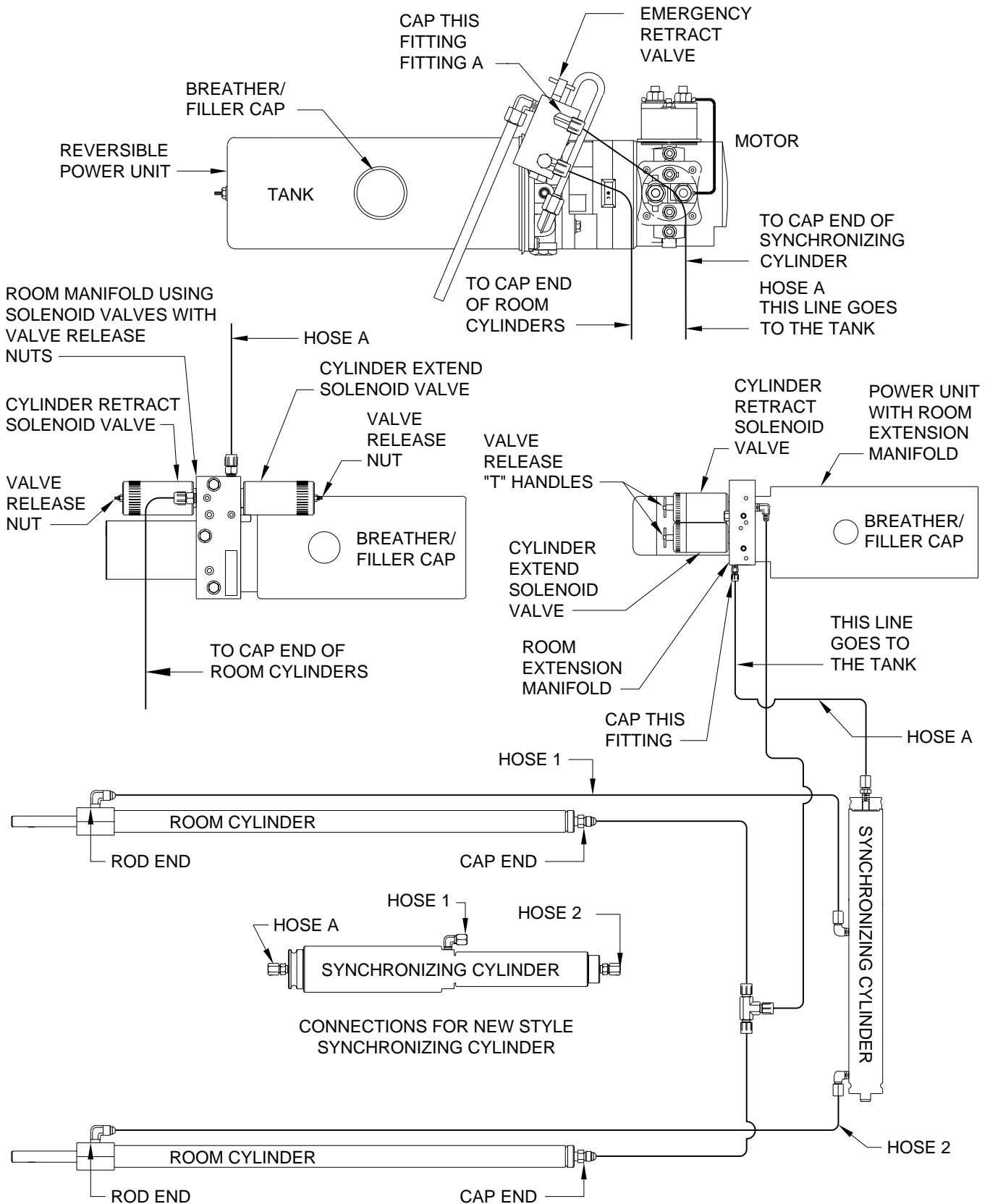

ALL TYPE A DUAL CYLINDER ROOM EXTENSIONS

# CYLINDER CONNECTION DIAGRAM DUAL CYLINDER ROOM EXTENSIONS (WITH SYNCRONIZING CYLINDER)

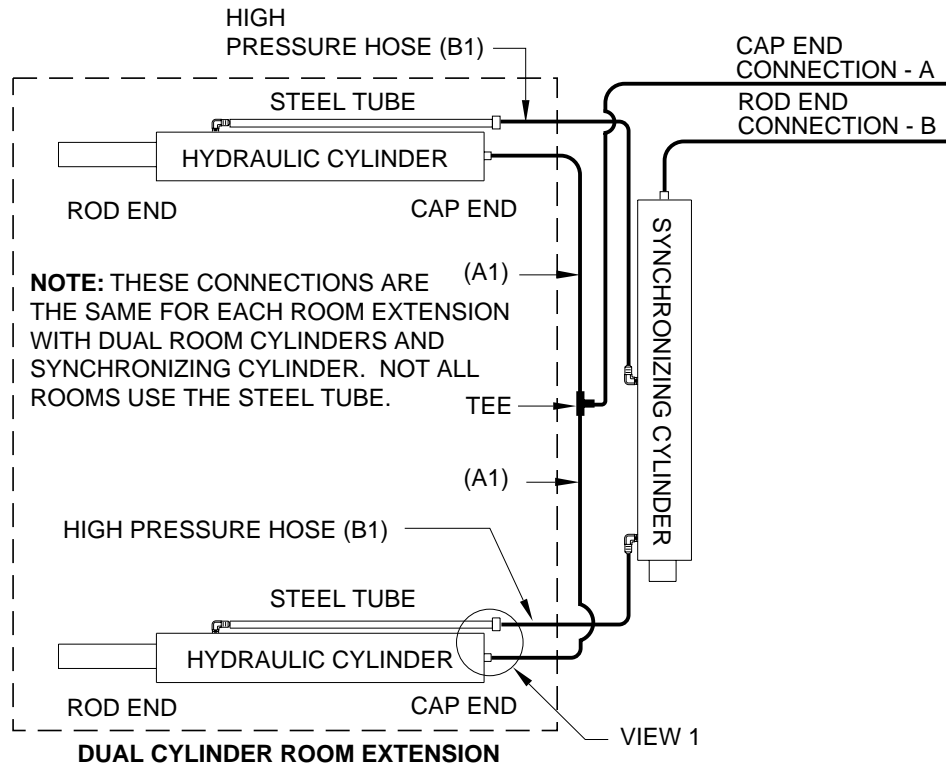

**IMPORTANT:** THE LINES (A1) BETWEEN THE CAP END OF THE HYDRAULIC CYLINDERS AND THE TEE MUST BE THE SAME LENGTH AND DIAMETER. THE LINES (B1) BETWEEN THE ROD END OF THE HYDRAULIC CYLINDERS AND THE SYNCRONIZING CYLINDER MUST BE THE SAME LENGTH AND DIAMETER. THE B1 LINES MUST BE HIGH PRESSURE HOSE.

**NOTE:** DIFFERENT TYPES OF HOSE, ESPECIALLY HIGH PRESSURE HOSE, HAS BEEN USED. THE PRINTING ON A 1/8" OR 3/16" HOSE BEING REPLACED MUST MATCH THE ORIGINAL HOSE. ALL HWH 1/4" HOSE IS THE SAME.

**VIEW 1**

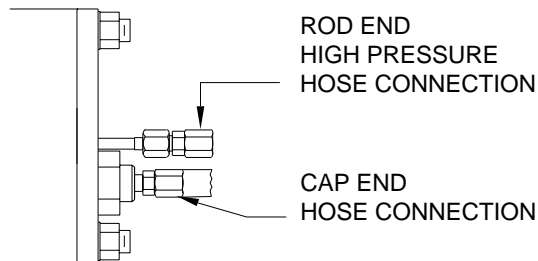

HOSE CONNECTION AT REAR OF  
ROOM EXTENSION TUBE

# HYDRAULIC LINE CONNECTION DIAGRAM ROOM EXTENSION - ONE OR TWO ROOMS SOLENOID VALVES WITH VALVE RELEASE "T" HANDLES

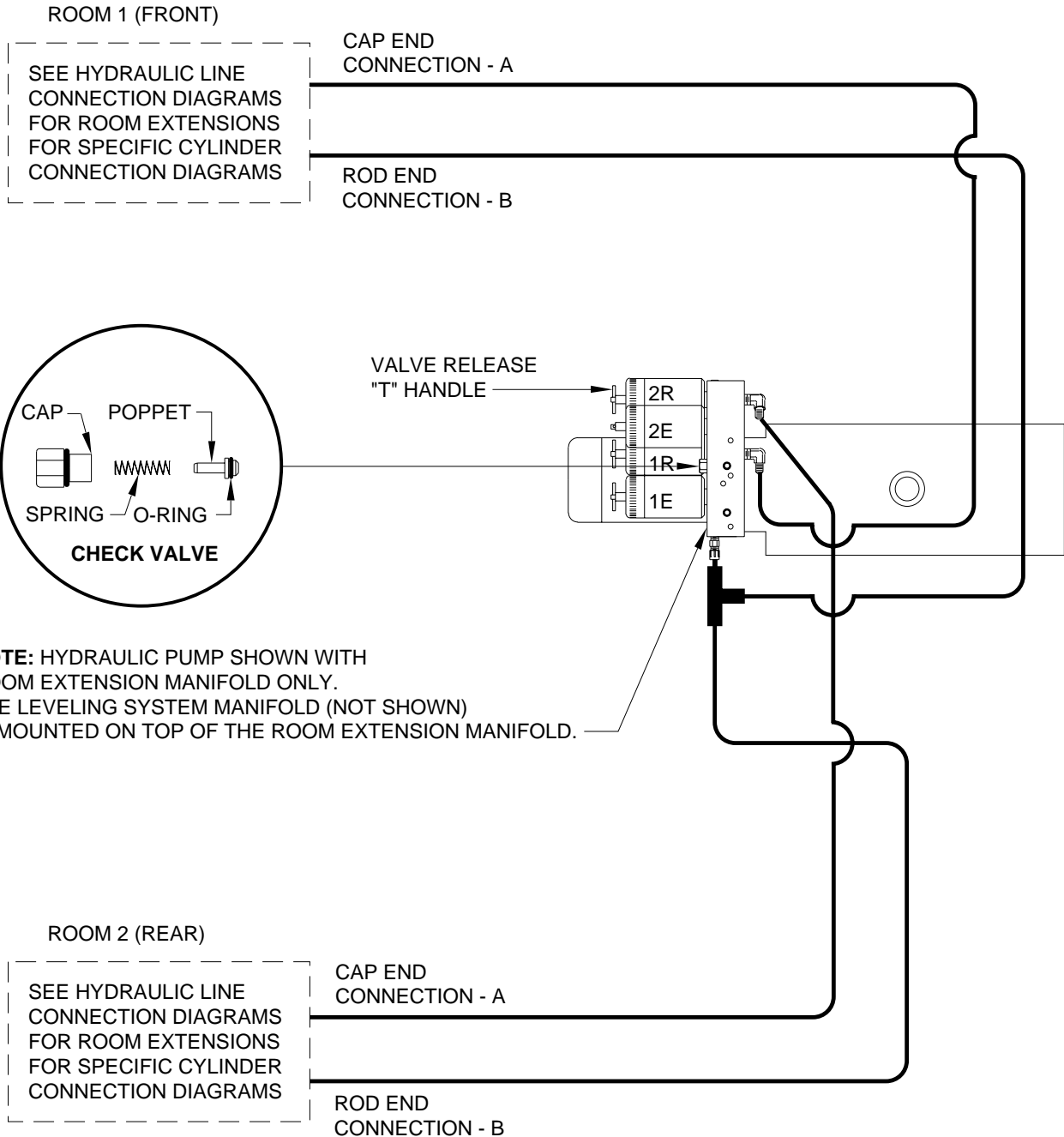

# HYDRAULIC LINE CONNECTION DIAGRAM ROOM EXTENSION - ONE OR TWO ROOMS SOLENOID VALVES WITH VALVE RELEASE NUTS

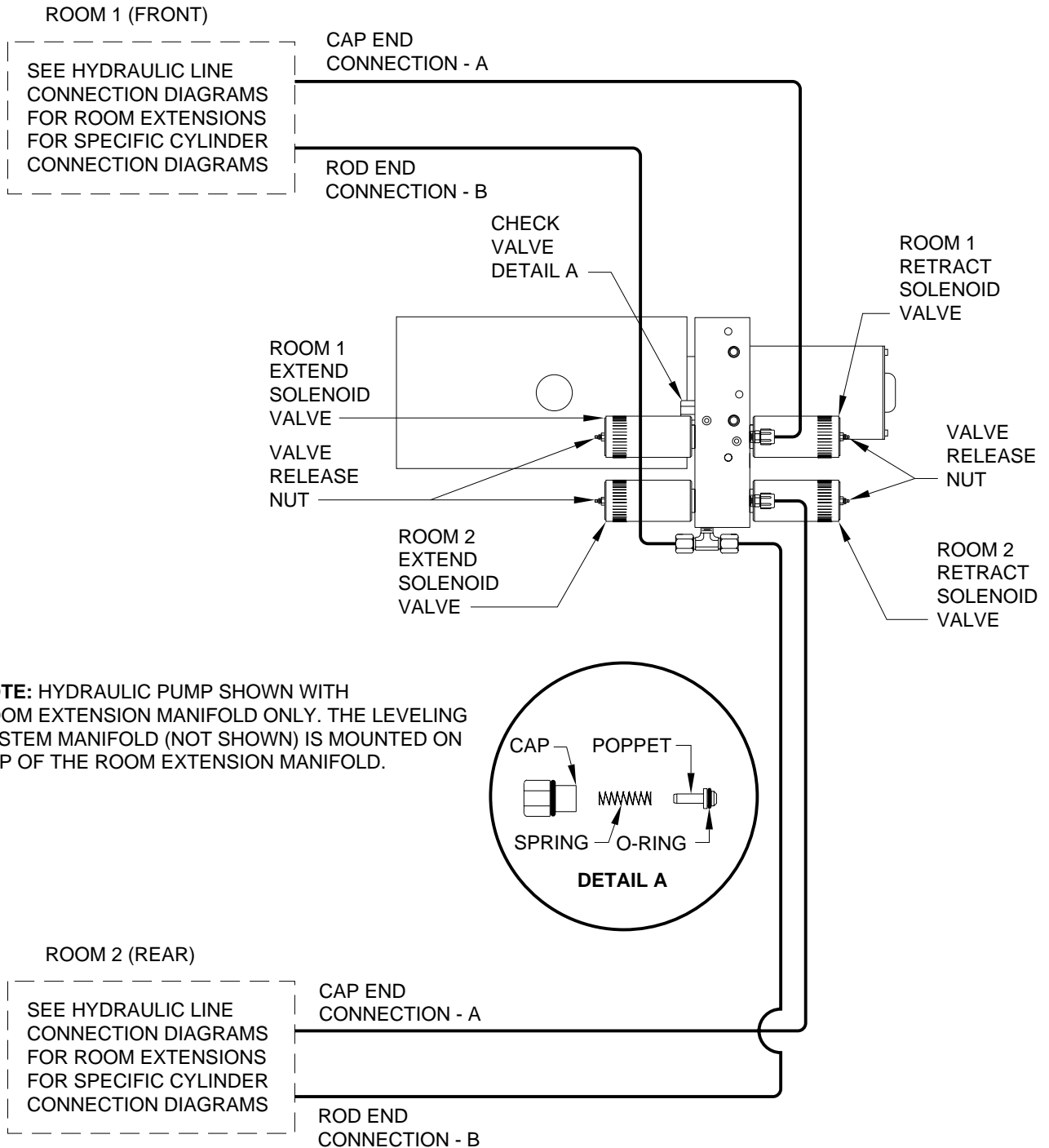

# HYDRAULIC LINE CONNECTION DIAGRAM FOUR CYLINDER ROOM EXTENSION (WITH SYNCHRONIZING CYLINDER)

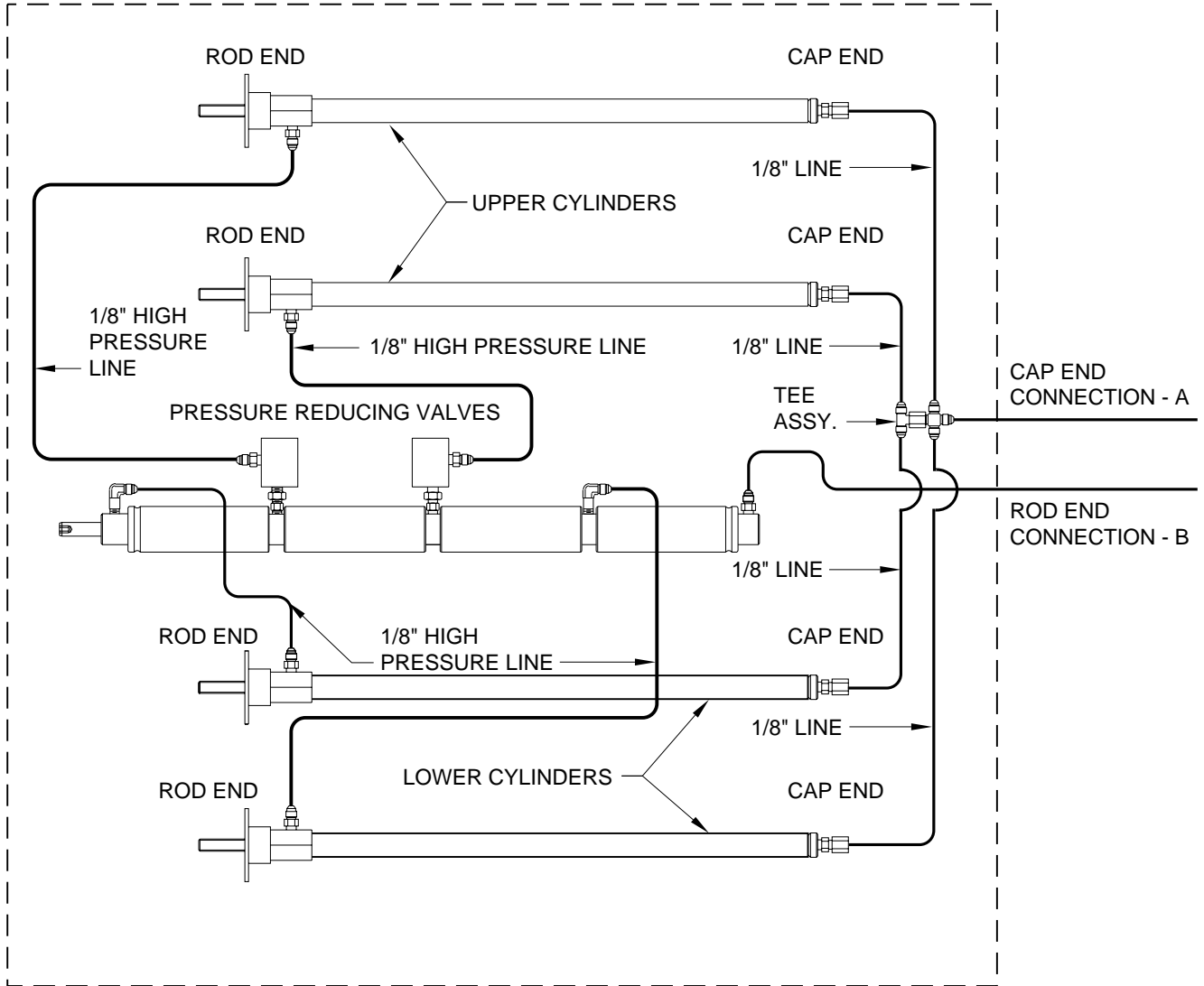

**IMPORTANT:** THE TWO LINES BETWEEN THE CAP END OF THE LOWER CYLINDERS AND THE TEE ASSEMBLY MUST BE THE SAME LENGTH AND DIAMETER.

THE TWO LINES BETWEEN THE ROD END OF THE LOWER CYLINDERS AND THE SYNCHRONIZING CYLINDER MUST BE HIGH PRESSURE HOSE THAT IS THE SAME LENGTH AND DIAMETER.

THE TWO LINES BETWEEN THE CAP END OF THE UPPER CYLINDERS AND THE TEE ASSEMBLY MUST BE THE SAME LENGTH AND DIAMETER.

THE TWO LINES BETWEEN THE ROD END OF THE UPPER CYLINDERS AND THE SYNCHRONIZING CYLINDER MUST BE HIGH PRESSURE HOSE THAT IS THE SAME LENGTH AND DIAMETER.



**NOTE:** THE PRESSURE REDUCING VALVES MAY BE IN A DIFFERENT POSITION ON THE SYNCHRONIZING CYLINDER. THEY WILL ALWAYS CONNECT TO THE ROD END OF THE UPPER CYLINDERS.



**HYDRAULIC FLOW DIAGRAM  
VERTICAL ARM OR DUAL CYLINDER ROOM EXTENSION  
WITH SYNCHRONIZING CYLINDER  
STATIONARY POSITION**

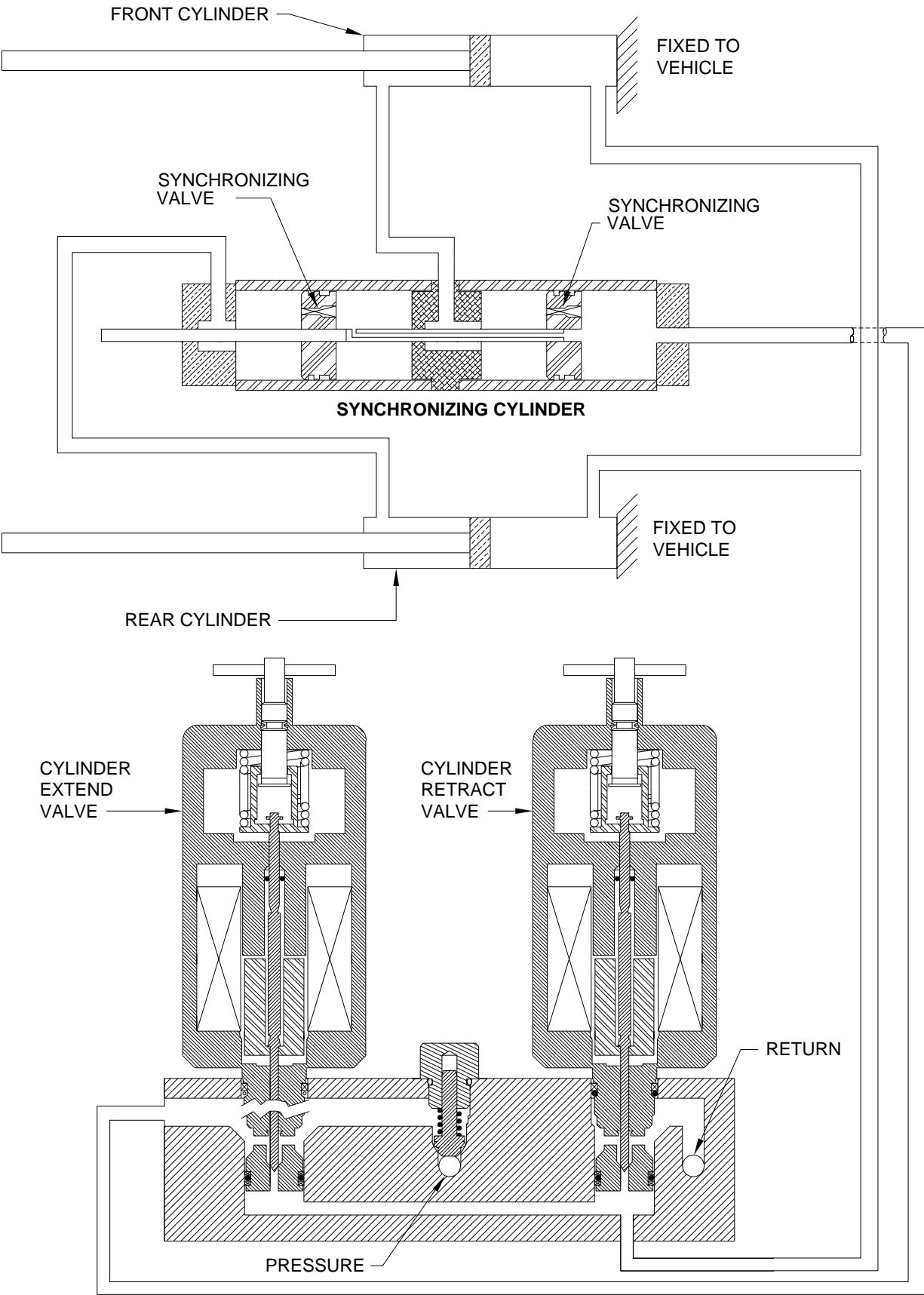

# HYDRAULIC FLOW DIAGRAM FOUR CYLINDER ROOM EXTENSION WITH SYNCHRONIZING CYLINDER

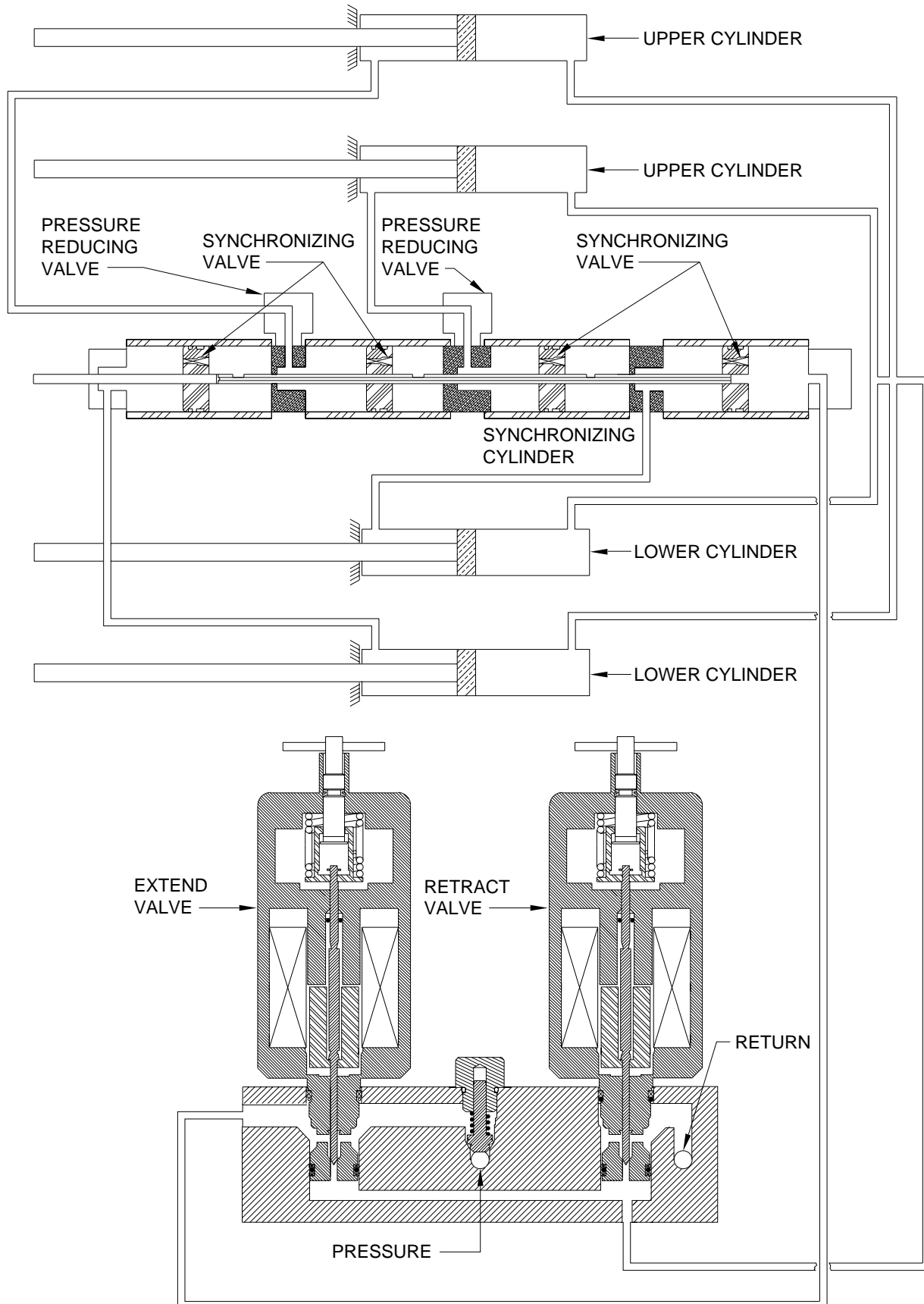

# **ELECTRICAL CONNECTION DIAGRAMS**

**FOR:  
COACHES WITH TWO ROOM EXTENSIONS  
ONE FLAT FLOOR OR  
DUAL CYLINDER ROOM EXTENSION  
(WITH SYNCRONIZING CYLINDER)  
AND  
ONE FOUR CYLINDER ROOM EXTENSION  
(WITH SYNCRONIZING CYLINDER)**

**310 SERIES LEVELING SYSTEM**

# ELECTRICAL CONNECTION DIAGRAM

## TWO ROOM EXTENSION SYSTEM

### 310 SERIES LEVELING SYSTEM

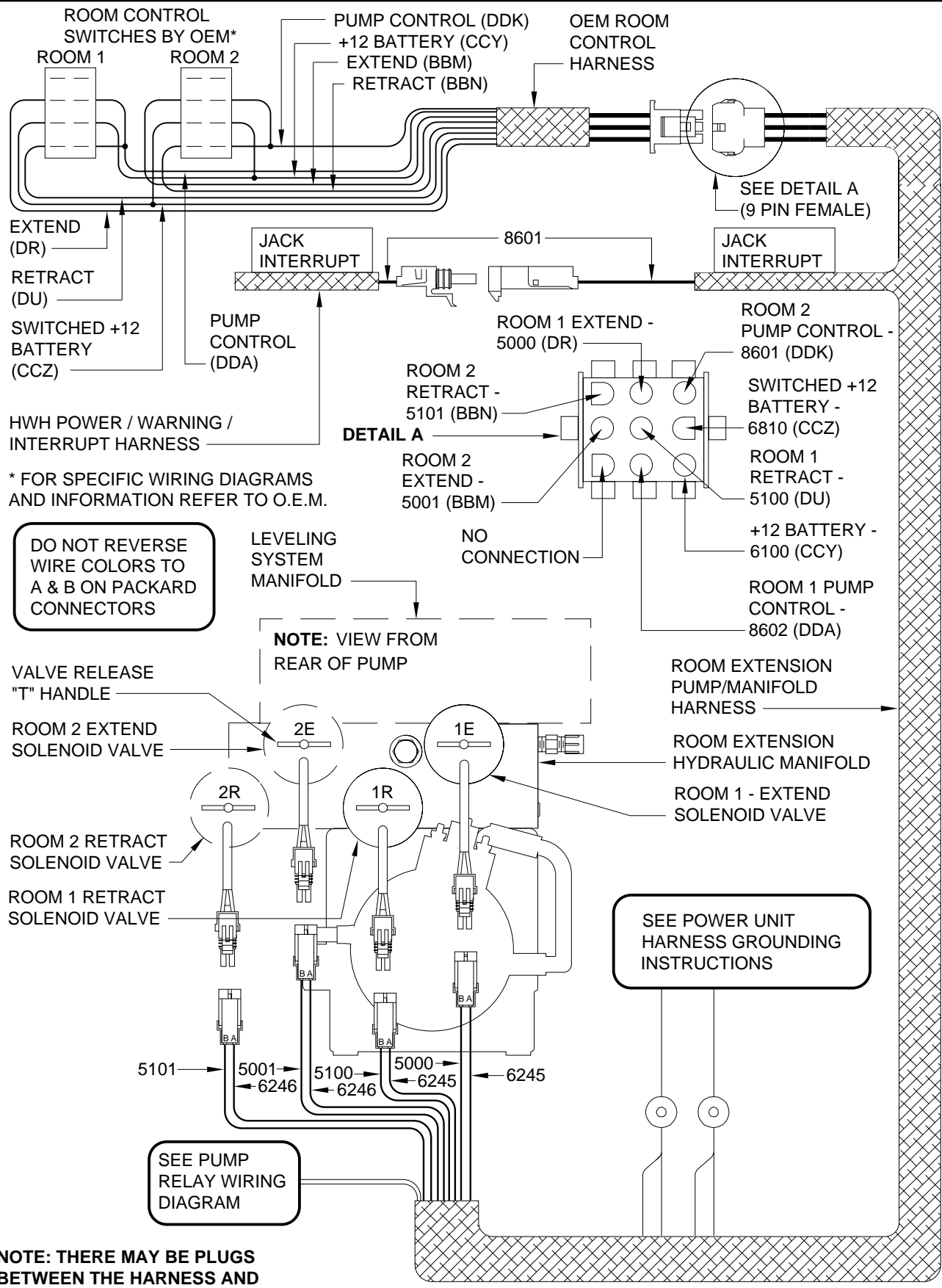

**NOTE: THERE MAY BE PLUGS BETWEEN THE HARNESS AND THE PUMP/MANIFOLD ASSEMBLY.**

**VIEW FROM PUMP END**

**MP85.321C**  
**19SEP00**

# ELECTRICAL CONNECTION DIAGRAM

## TWO ROOM EXTENSION SYSTEM (ONE FOUR CYL ROOM EXTENSION)

### 310 SERIES LEVELING SYSTEM

### SOLENOID VALVES WITH VALVE RELEASE NUTS

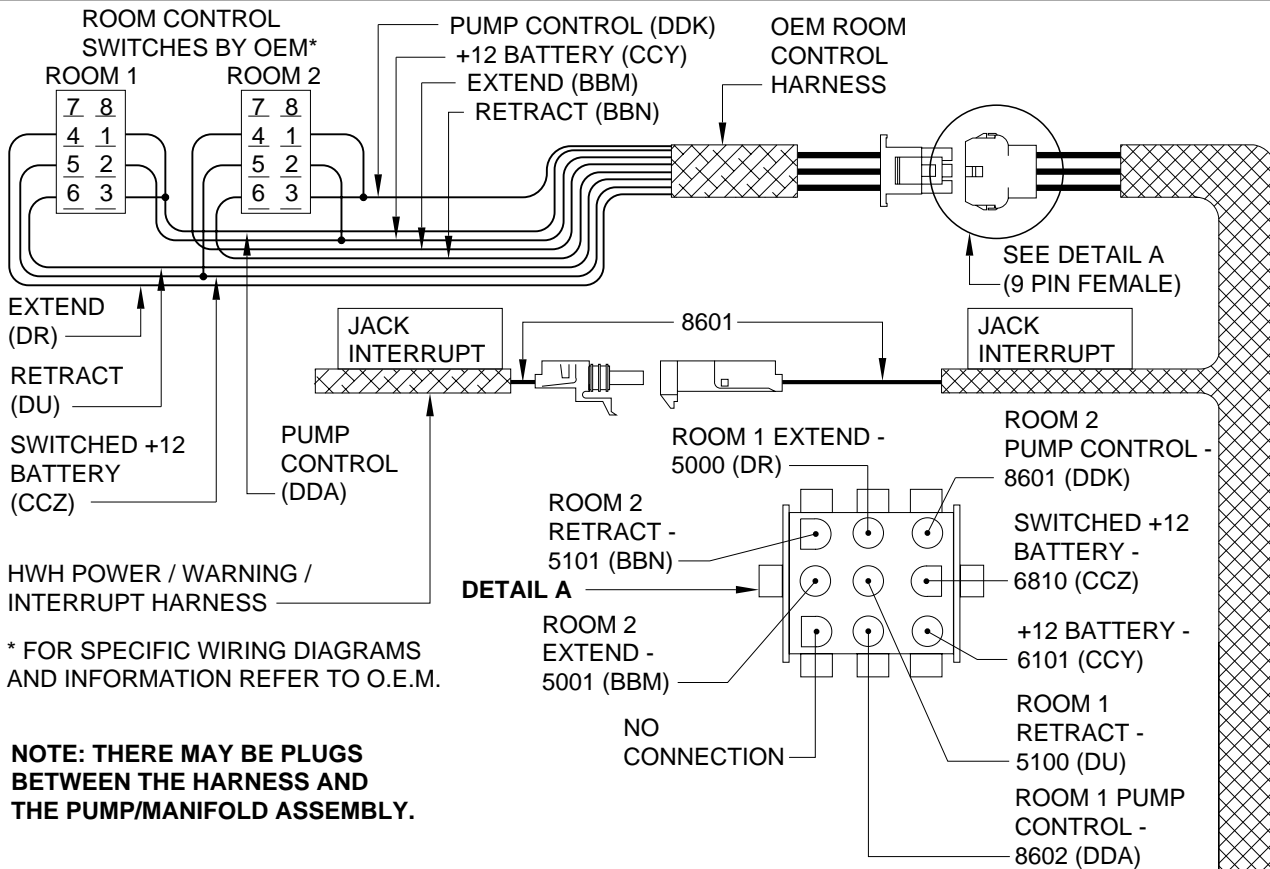

#### TOP VIEW OF PUMP/MANIFOLD

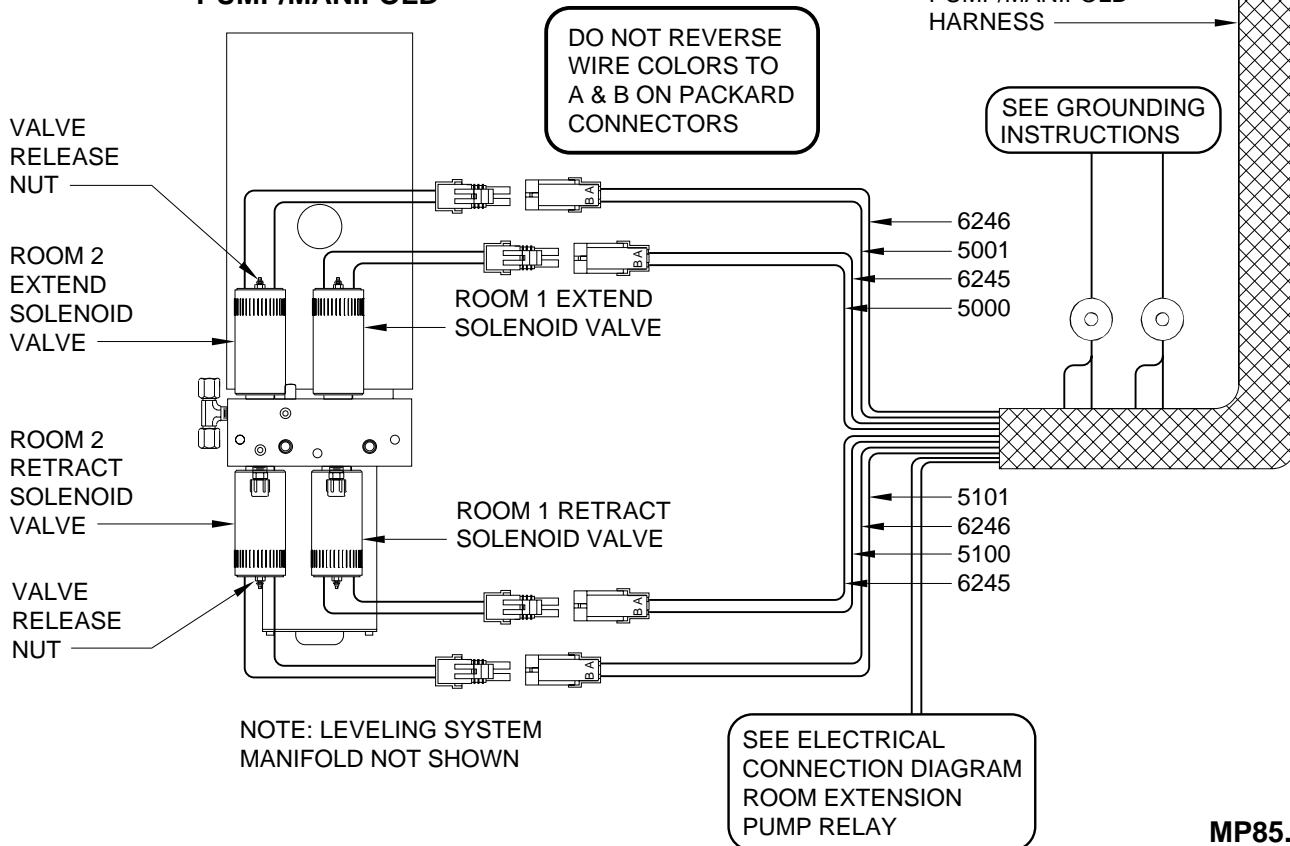

# ELECTRICAL CONNECTION DIAGRAM 310 SERIES LEVELING SYSTEM PUMP RELAYS WITH TWO ROOM EXTENSIONS

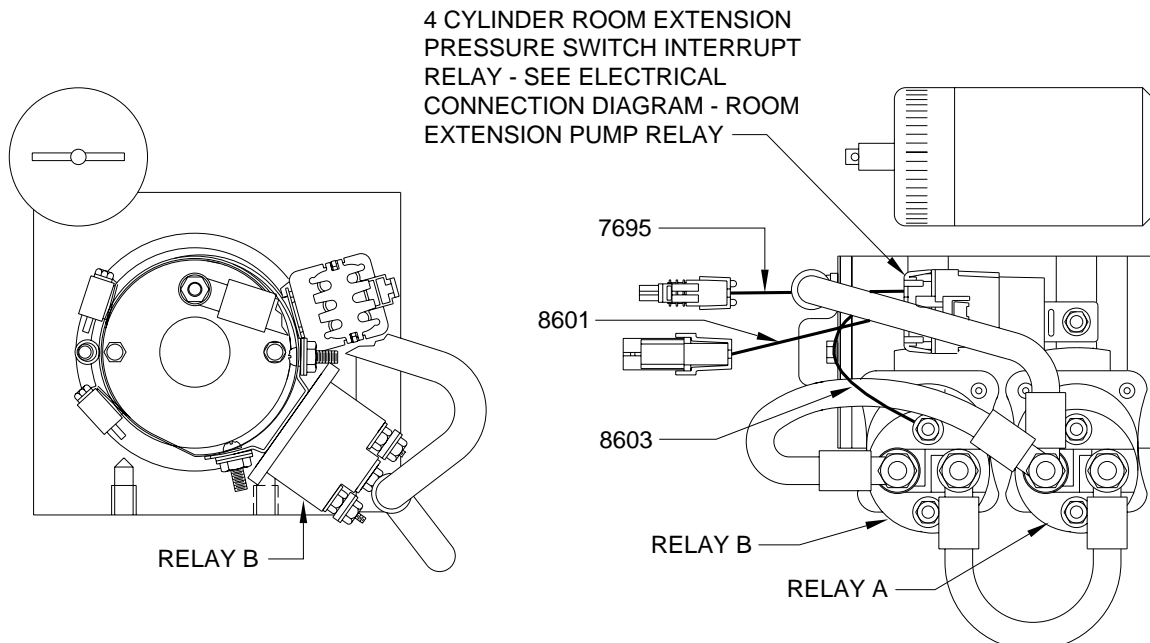
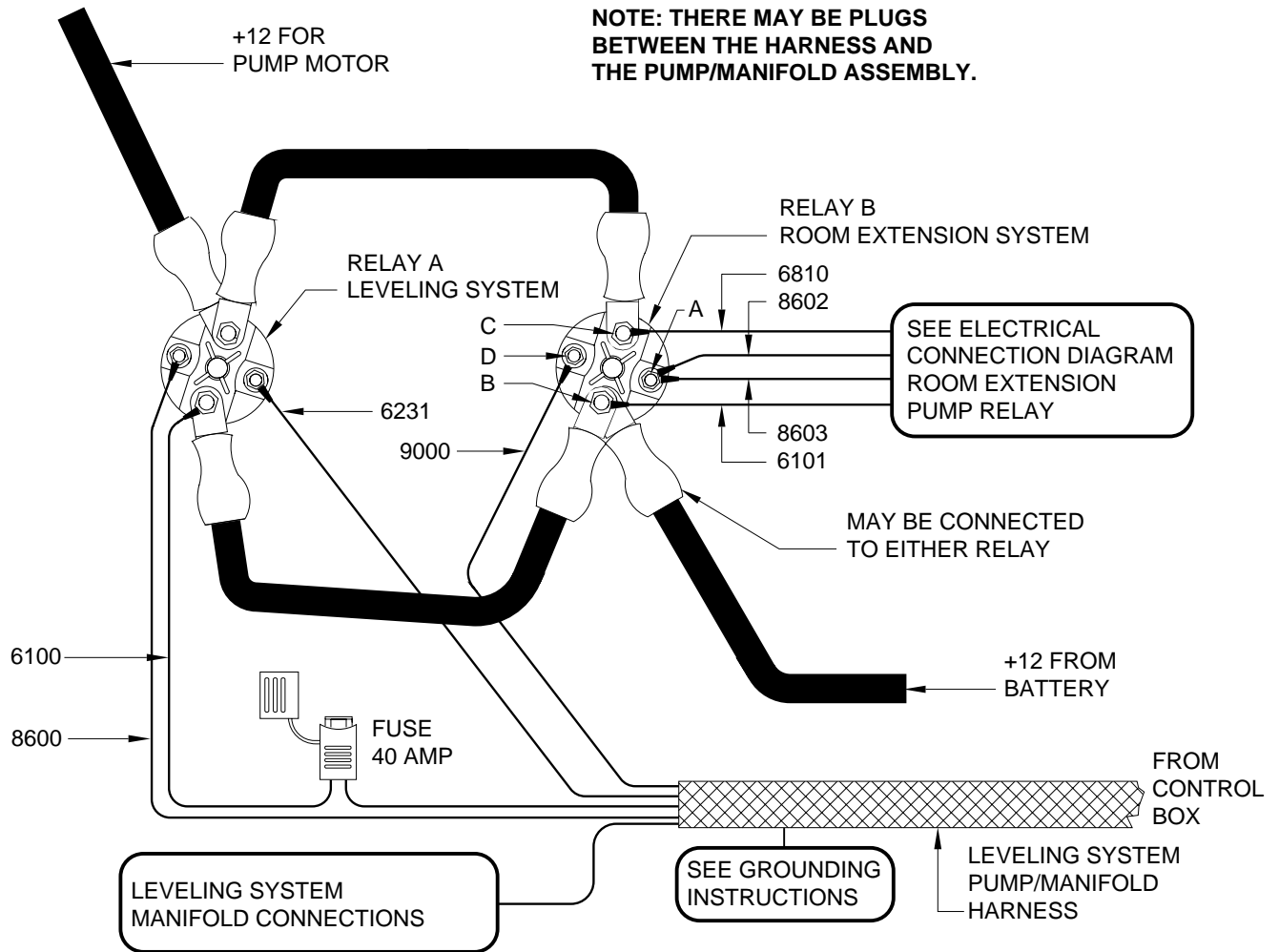

# ELECTRICAL CONNECTION DIAGRAM ROOM EXTENSION PUMP RELAY TWO ROOM EXTENSIONS (ONE FOUR CYL ROOM EXTENSION)

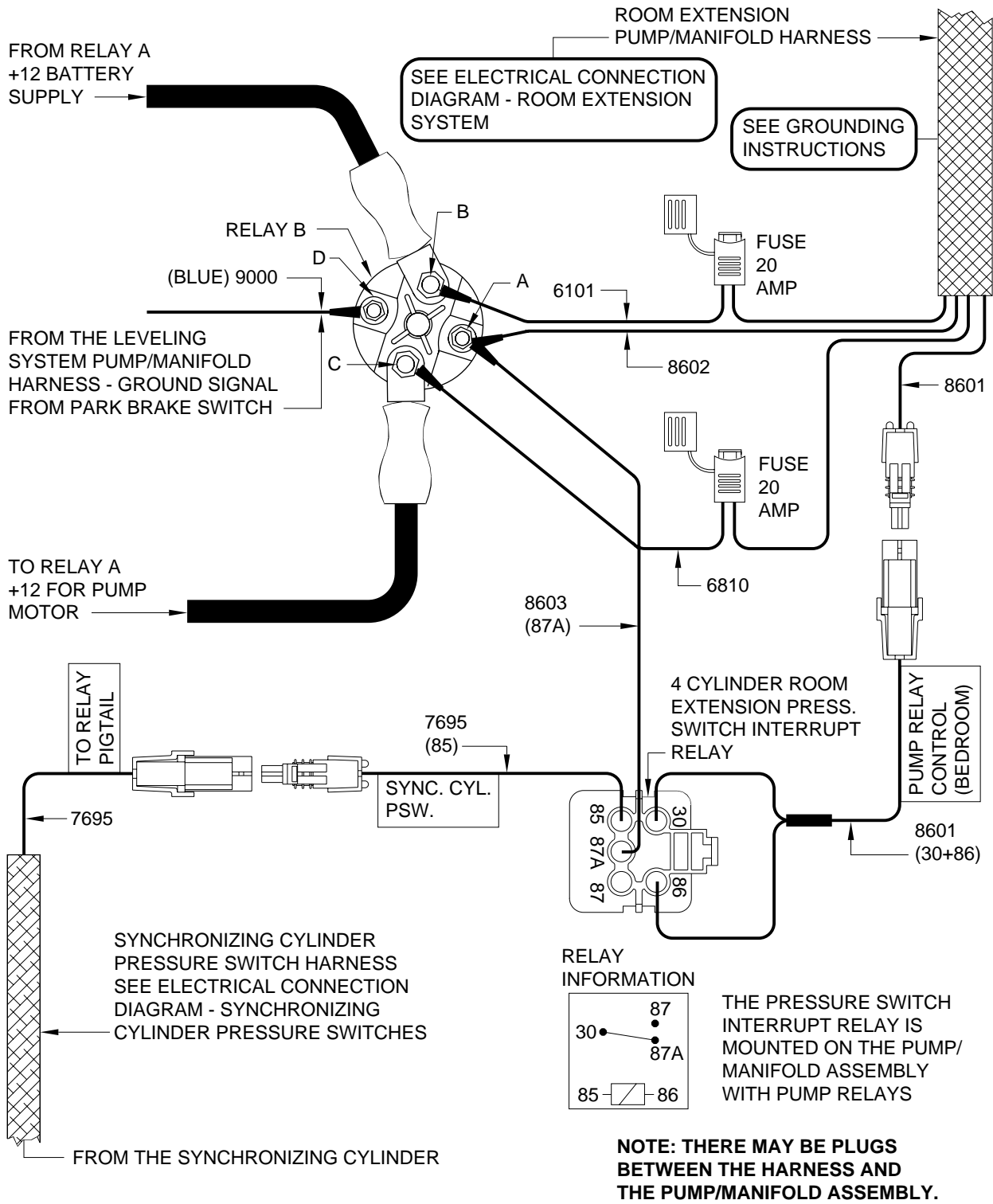

**NOTE:** THE (4) DIGIT WIRE NUMBER SUPERSEDES ANY AND ALL WIRE COLORS.

# ELECTRICAL CONNECTION DIAGRAM ROOM EXTENSION SYNCHRONIZING CYLINDER PRESSURE SWITCHES

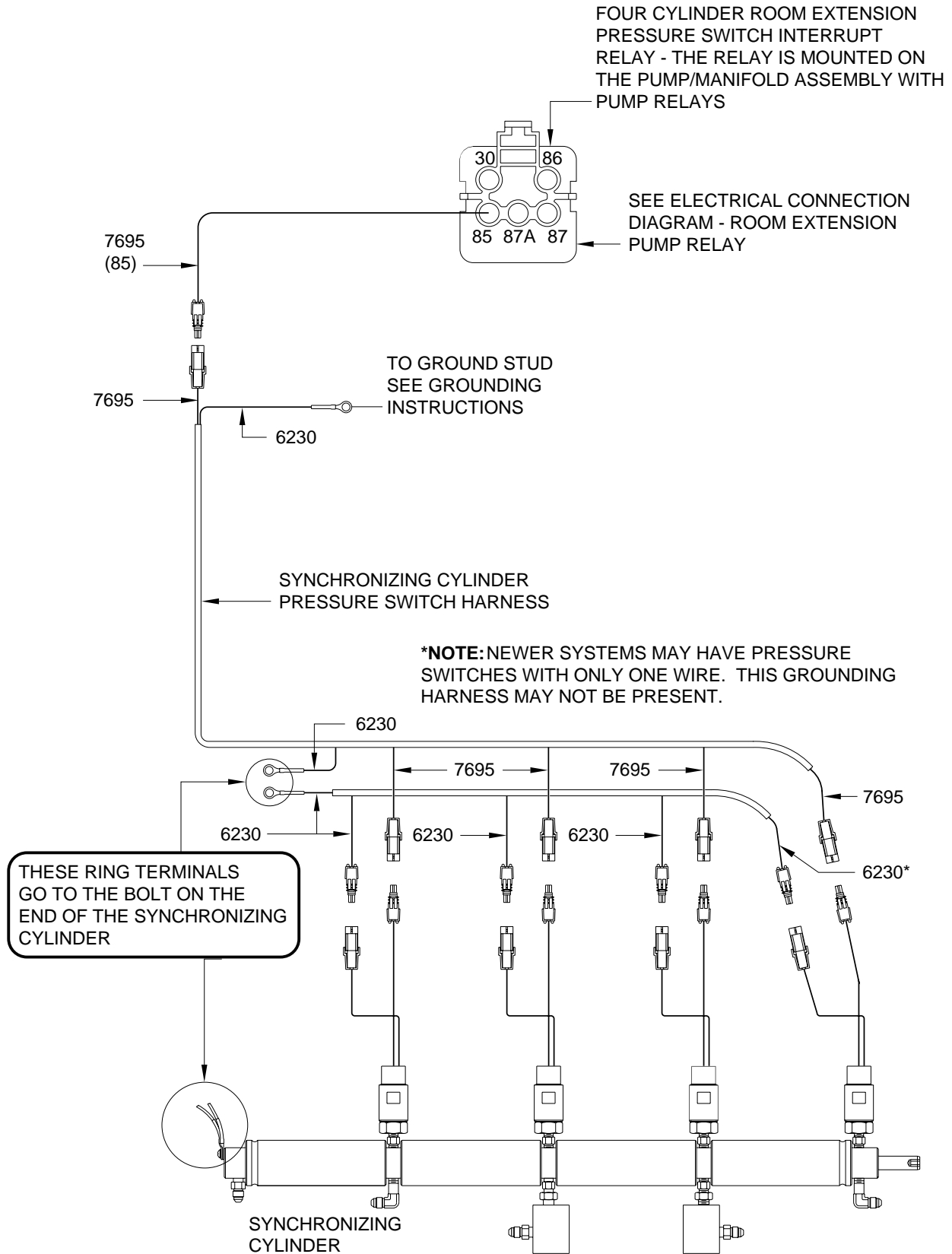



# ELECTRICAL CONNECTION DIAGRAM

## 310 SERIES LEVELING SYSTEM WITH ROOM EXTENSIONS

### POWER HARNESS AND MASTER WARNING INDICATORS

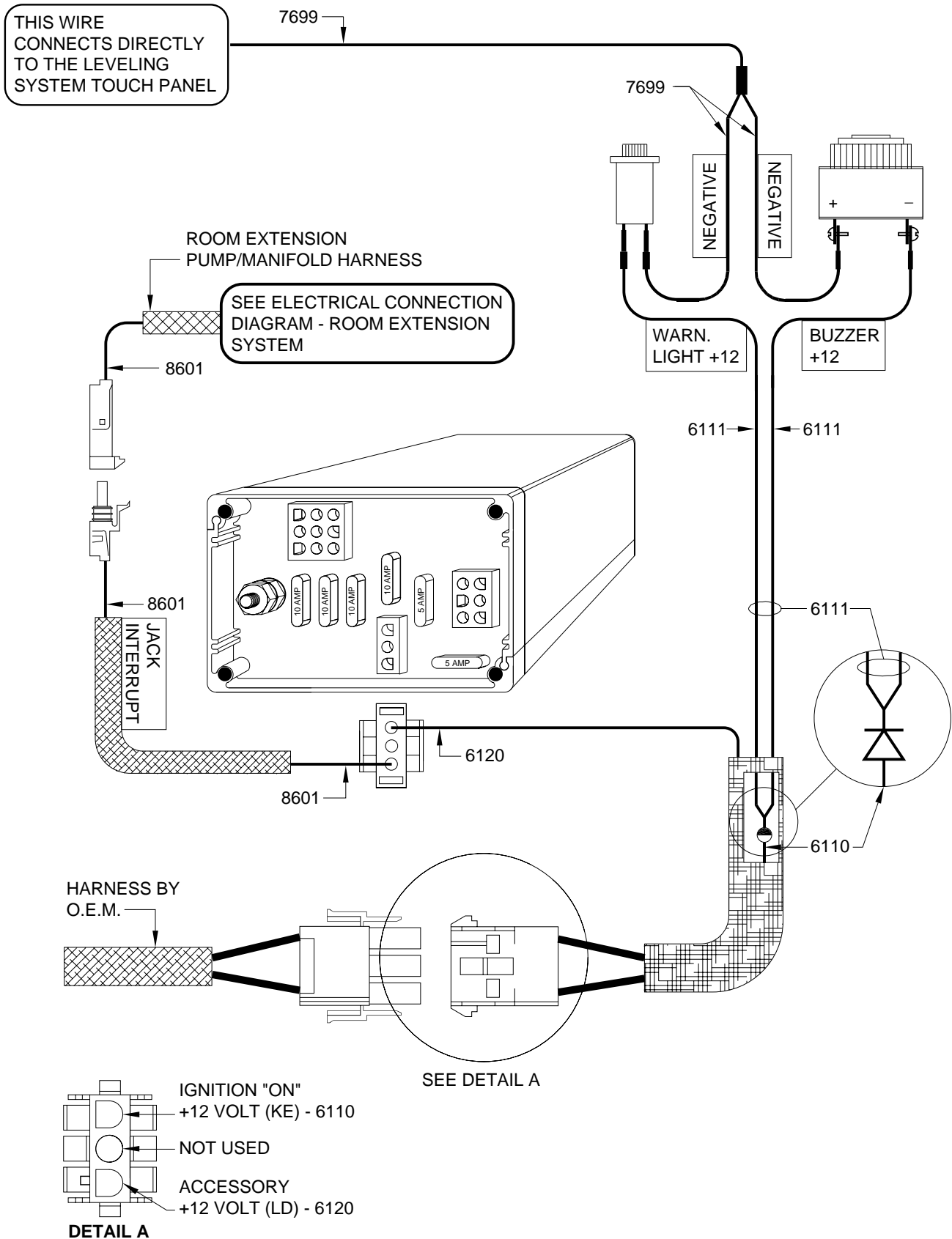

**MP85.324G**  
**180CT00**

SAME AS (MP85304C)

# ELECTRICAL CONNECTION DIAGRAM

## 310 SERIES LEVELING SYSTEM WITH TWO ROOM EXTENSIONS

### POWER UNIT/MANIFOLD PIGTAIL ASSEMBLY

COACHES BEFORE MID - YEAR 2000 DID NOT HAVE THE PIGTAIL ASSEMBLY. REFER TO THE DIAGRAMS IN THIS MANUAL FOR CORRECT INFORMATION. COACHES BUILT AFTER MID - YEAR 2000 MAY HAVE THE PIGTAIL ASSEMBLY. COMPONENT CONNECTIONS WILL REMAIN THE SAME. THIS PAGE SHOWS THE PLUG CONNECTIONS FOR THE MAIN HARNESSSES.

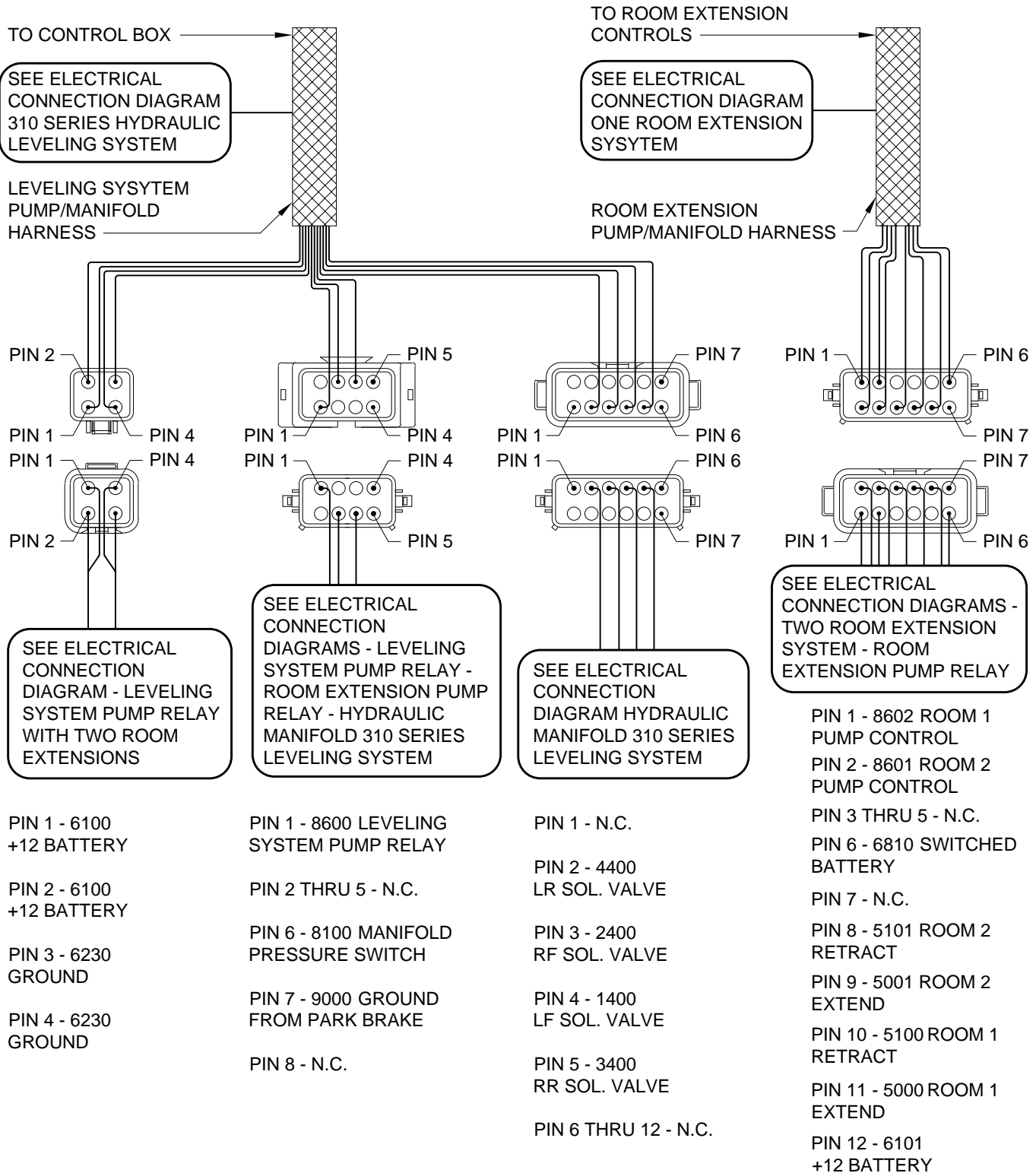

# ELECTRICAL CONNECTION DIAGRAM GROUNDING INSTRUCTIONS 310 SERIES LEVELING SYSTEM (WITH ROOM EXTENSION)

## WELDED PUMP MOUNT

USING GROUNDING STUD AND 3/8" EXTERNAL STAR LOCKWASHERS AS SHOWN.

**IMPORTANT:** STAR LOCKWASHERS MUST BE USED BETWEEN GROUNDING SURFACE AND WIRE TERMINALS.

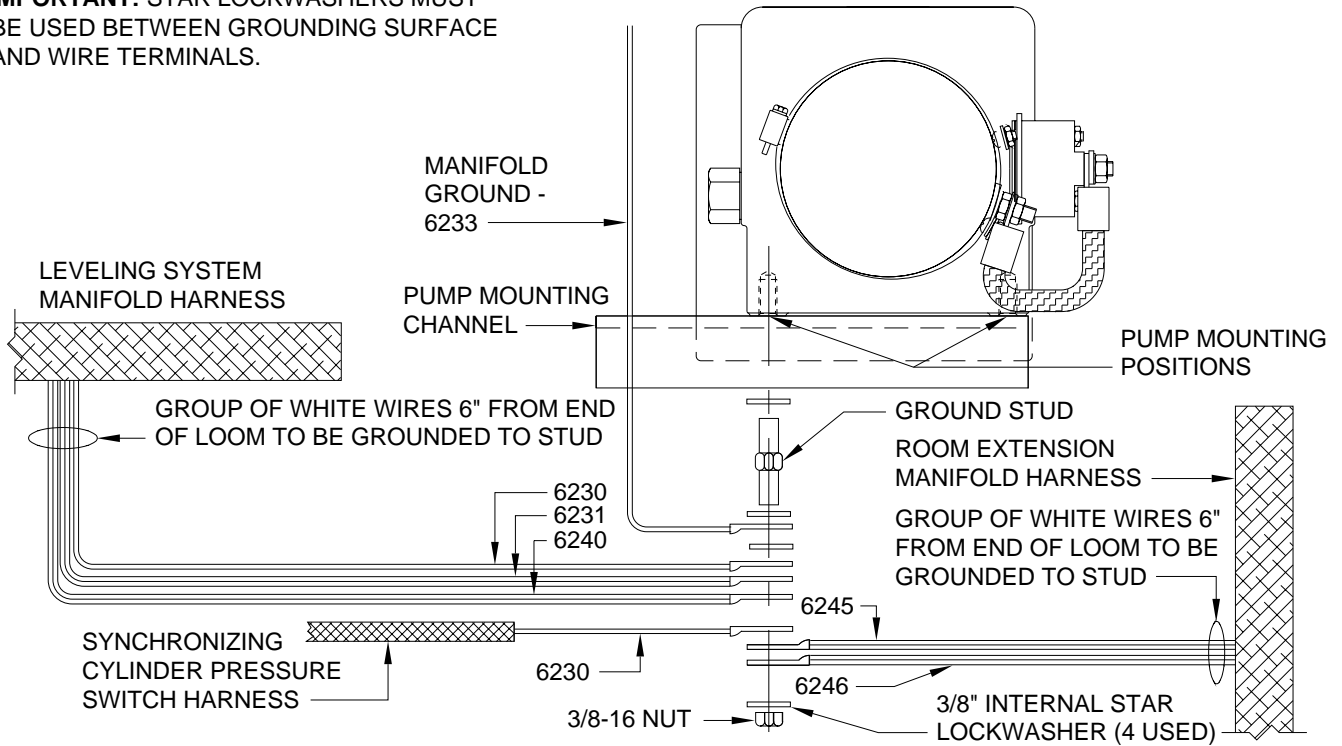

## PUMP MOUNTED REMOTE FROM FRAME

USE GROUNDING STUD AND 3/8" EXTERNAL STAR LOCKWASHERS AS SHOWN.

**IMPORTANT:** STAR LOCK WASHERS MUST BE USED BETWEEN GROUNDING SURFACE AND WIRE TERMINALS.

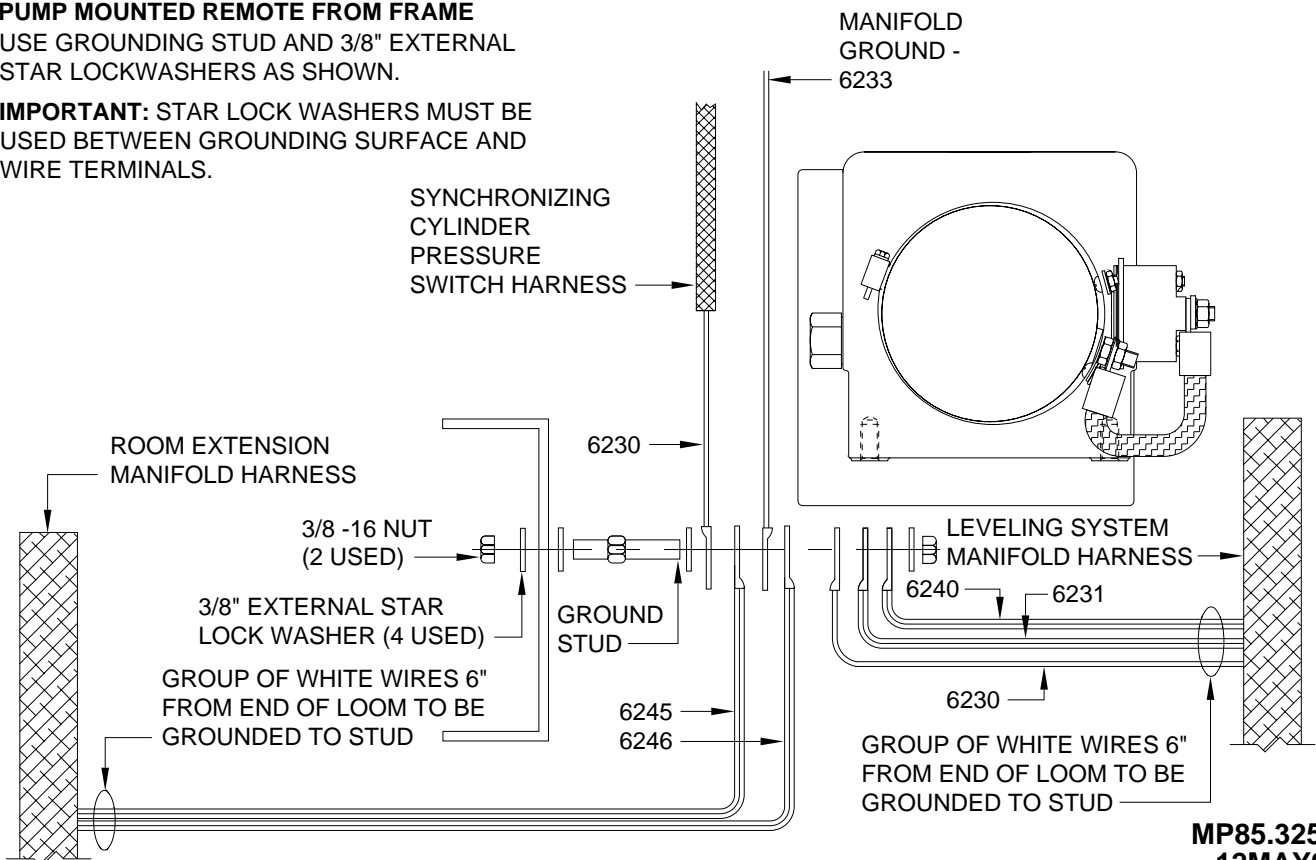

# **ELECTRICAL CONNECTION DIAGRAMS**

**FOR:  
COACHES WITH TWO ROOM EXTENSIONS  
ONE FLAT FLOOR OR  
DUAL CYLINDER ROOM EXTENSION  
(WITH SYNCRONIZING CYLINDER)  
AND  
ONE FOUR CYLINDER ROOM EXTENSION  
(WITH SYNCRONIZING CYLINDER)**

**610 SERIES LEVELING SYSTEM**

# ELECTRICAL CONNECTION DIAGRAM

## 610 SERIES LEVELING SYSTEM WITH TWO ROOM EXTENSIONS

### SOLENOID VALVES WITH VALVE RELEASE "T" HANDLES

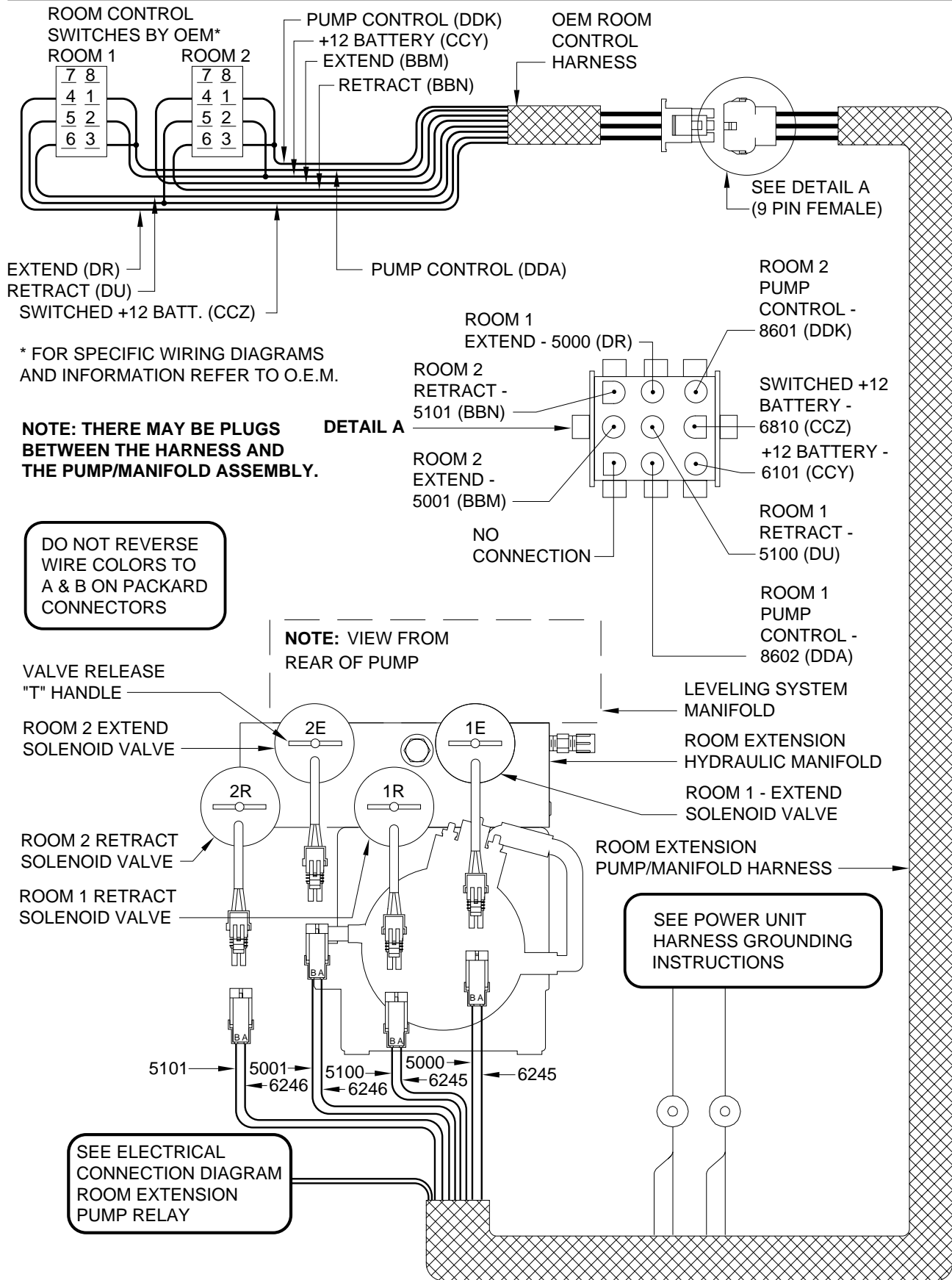

VIEW FROM PUMP END

# ELECTRICAL CONNECTION DIAGRAM

## 610 SERIES LEVELING SYSTEM WITH TWO ROOM EXTENSIONS

### SOLENOID VALVES WITH VALVE RELEASE NUTS

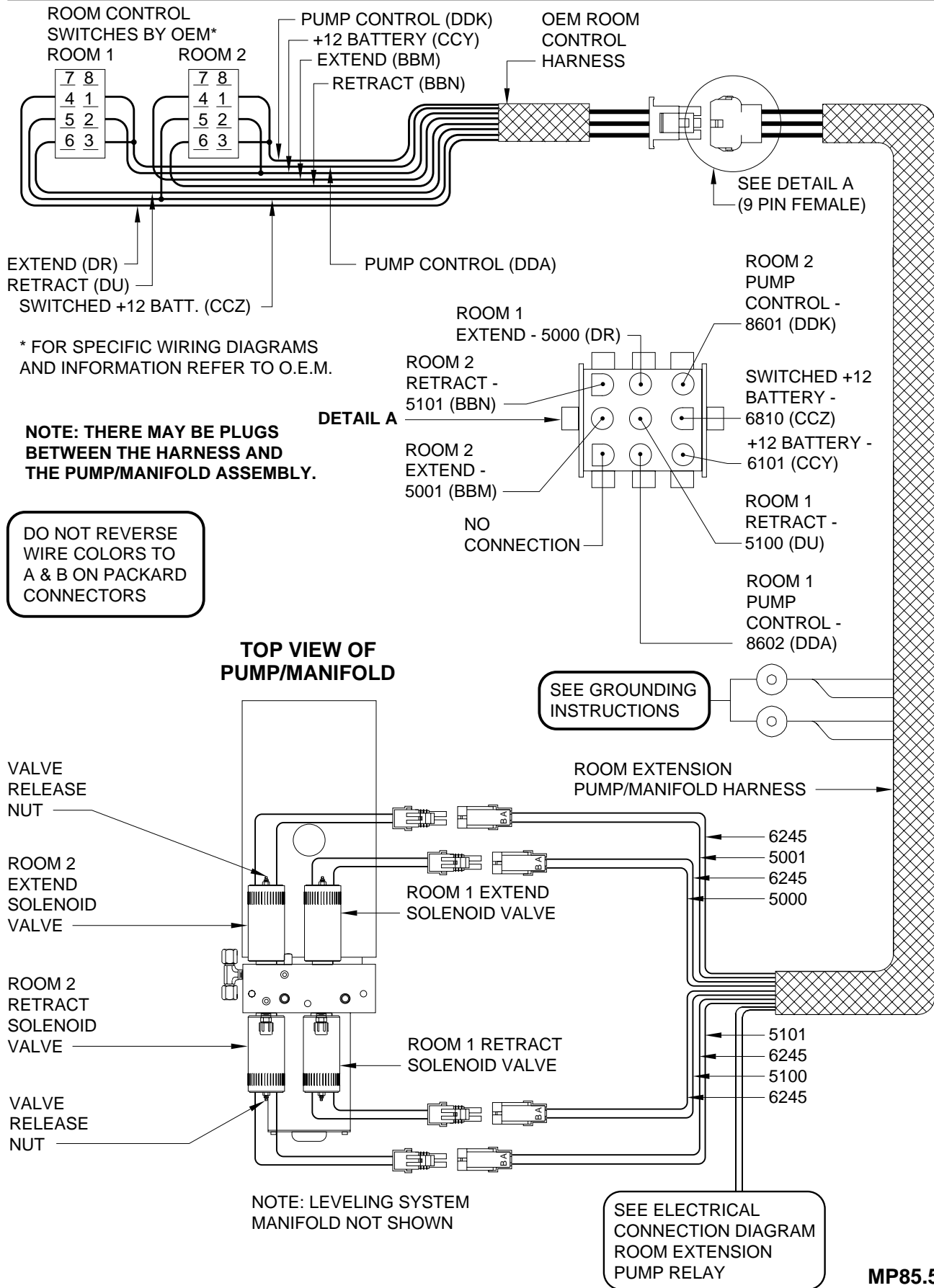

# ELECTRICAL CONNECTION DIAGRAM

## 610 SERIES LEVELING SYSTEM WITH TWO ROOM EXTENSIONS

### MASTER AND PUMP RELAY

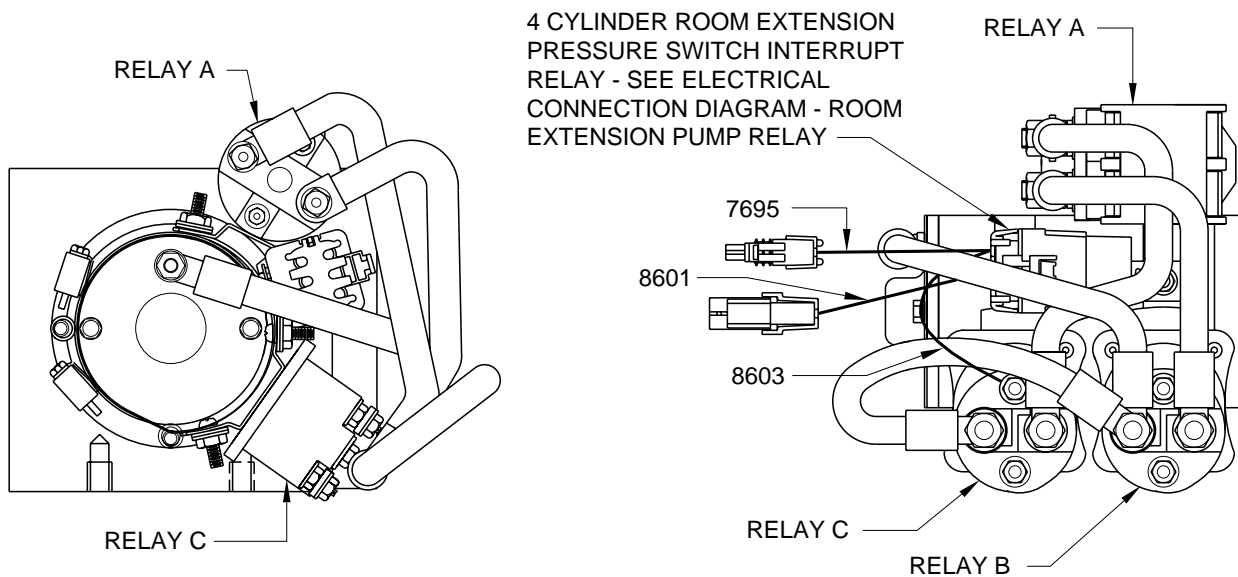
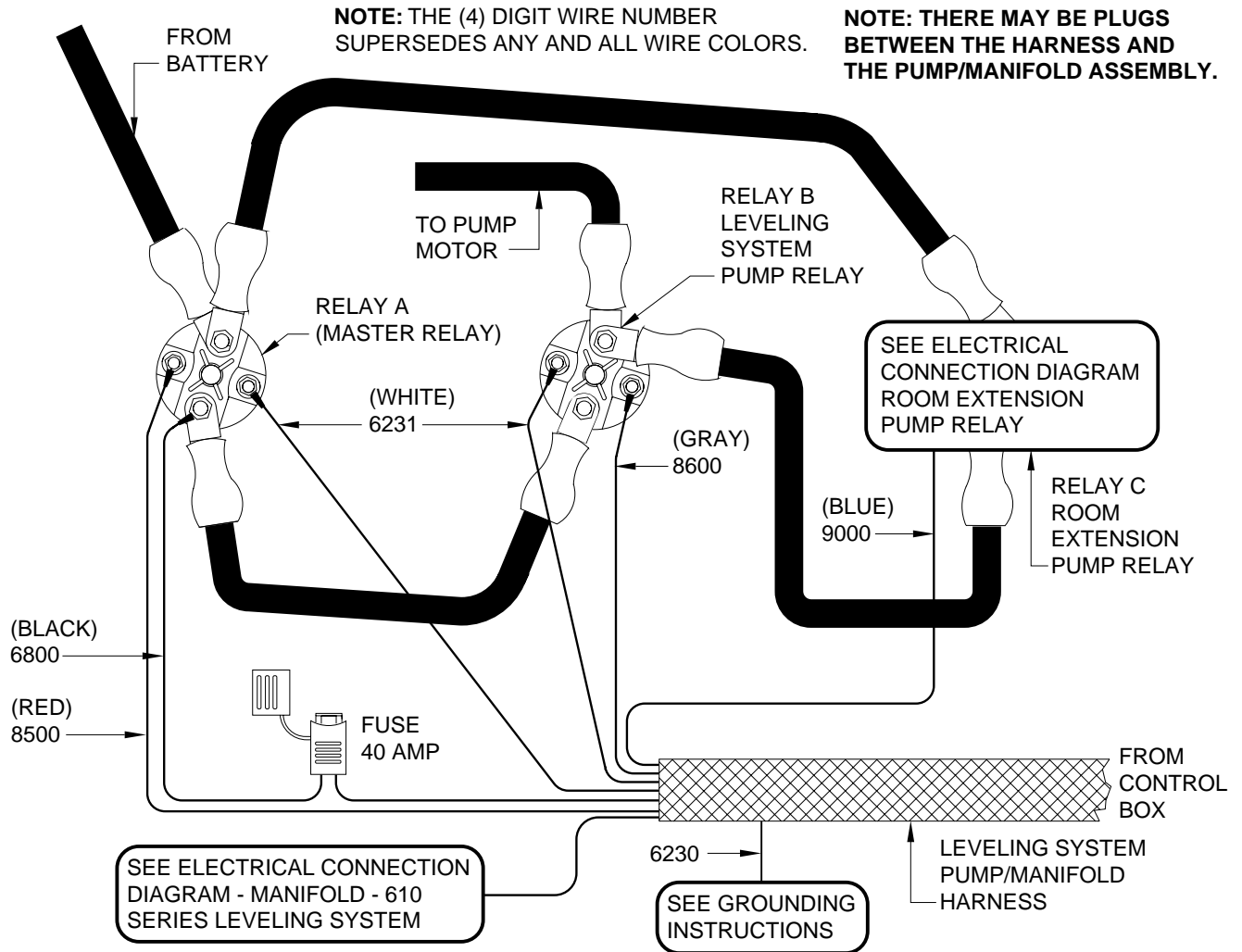

# ELECTRICAL CONNECTION DIAGRAM ROOM EXTENSION PUMP RELAY TWO ROOM EXTENSIONS (ONE FOUR CYL ROOM EXTENSION)

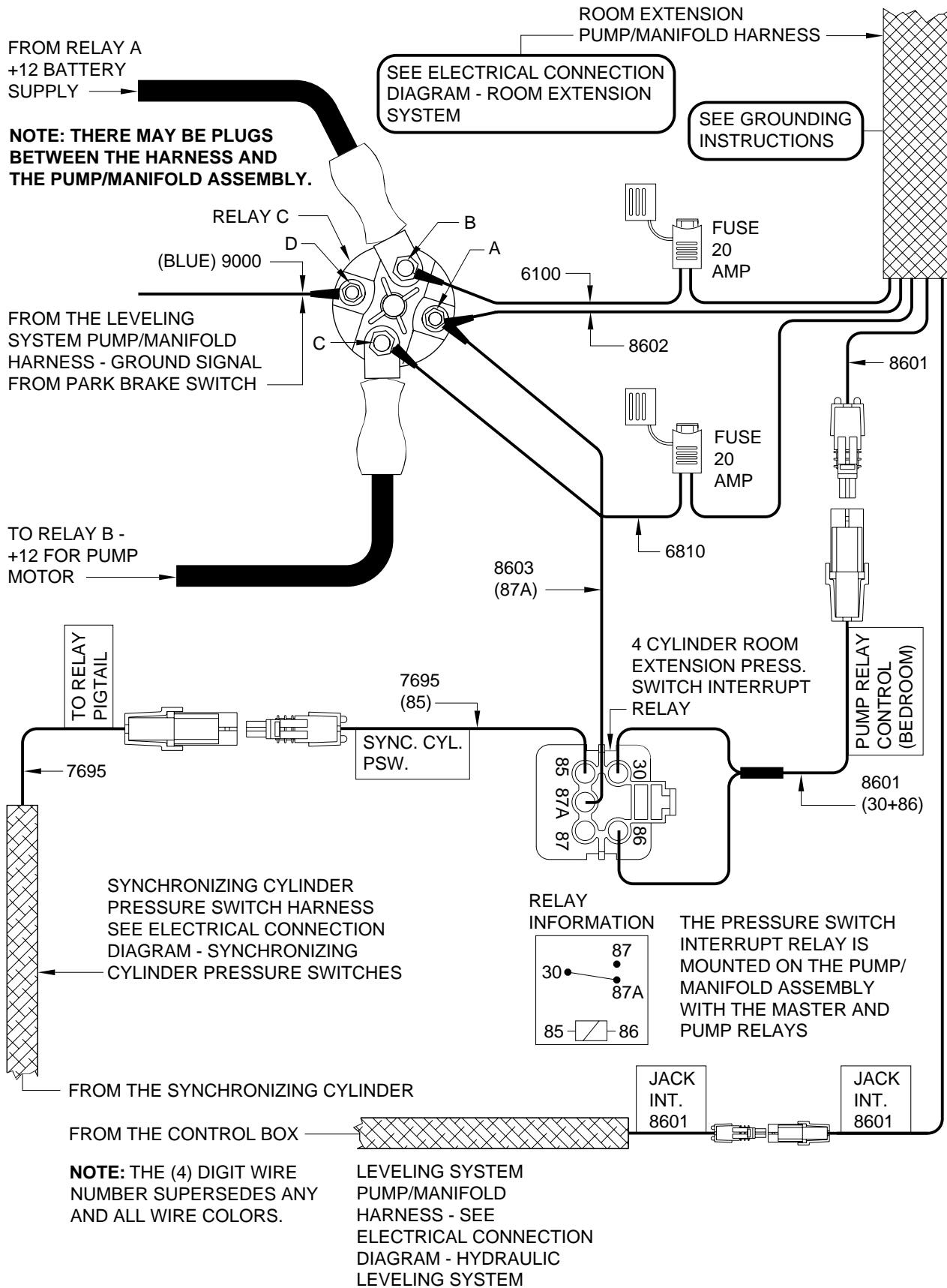



# ELECTRICAL CONNECTION DIAGRAM

## 610 SERIES LEVELING SYSTEM WITH TWO ROOM EXTENSIONS

### POWER UNIT/MANIFOLD PIGTAIL ASSEMBLY

COACHES BEFORE MID - YEAR 2000 DID NOT HAVE THE PIGTAIL ASSEMBLY. REFER TO THE DIAGRAMS IN THIS MANUAL FOR CORRECT INFORMATION. COACHES BUILT AFTER MID - YEAR 2000 MAY HAVE THE PIGTAIL ASSEMBLY. COMPONENT CONNECTIONS WILL REMAIN THE SAME. THIS PAGE SHOWS THE PLUG CONNECTIONS FOR THE MAIN HARNESSSES.

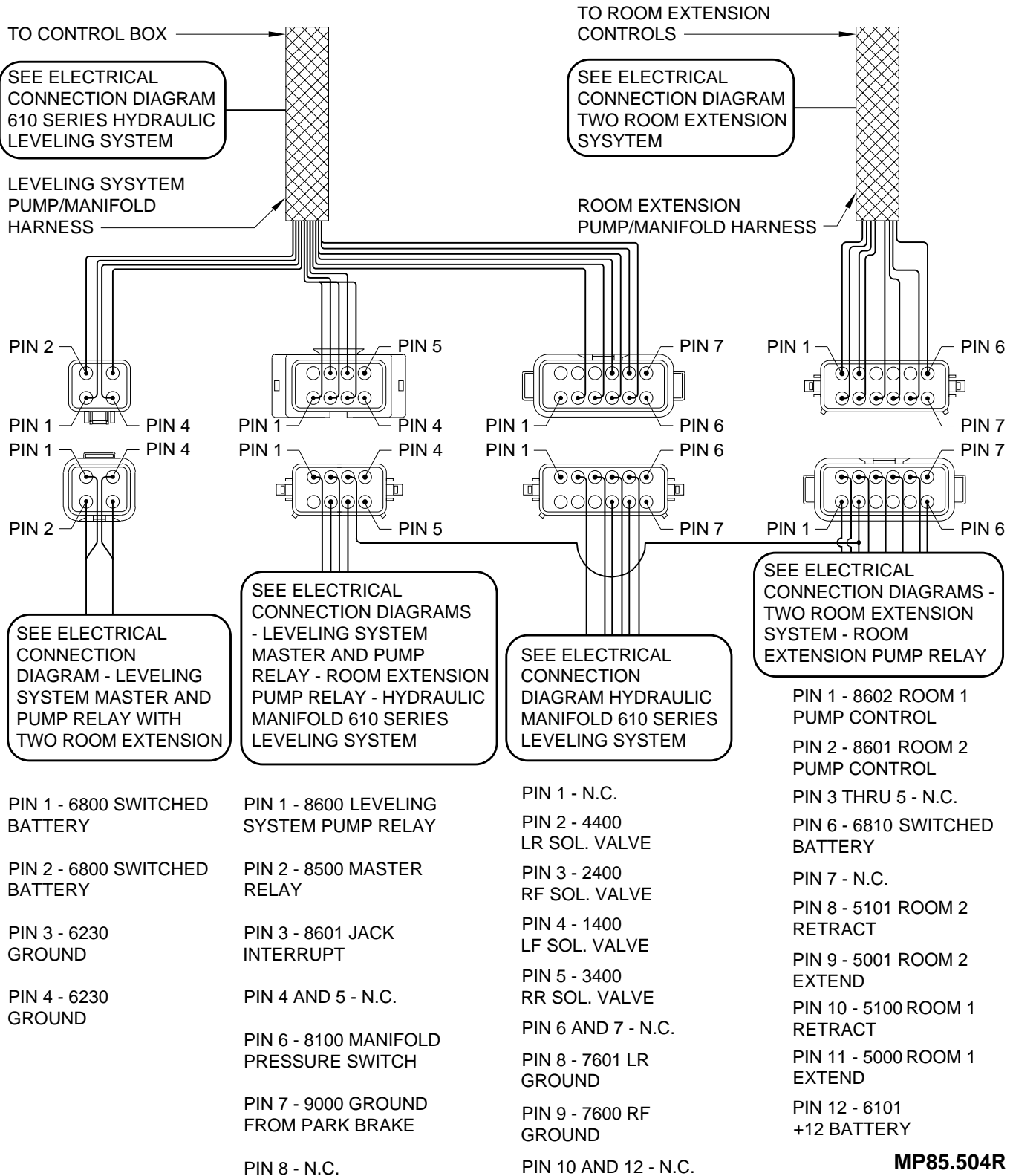

# ELECTRICAL CONNECTION DIAGRAM

## 610 SERIES LEVELING SYSTEM WITH ROOM EXTENSIONS

### POWER HARNESS AND MASTER WARNING INDICATORS

**NOTE:** THE (4) DIGIT WIRE NUMBER SUPERSEDES ANY AND ALL WIRE COLORS.

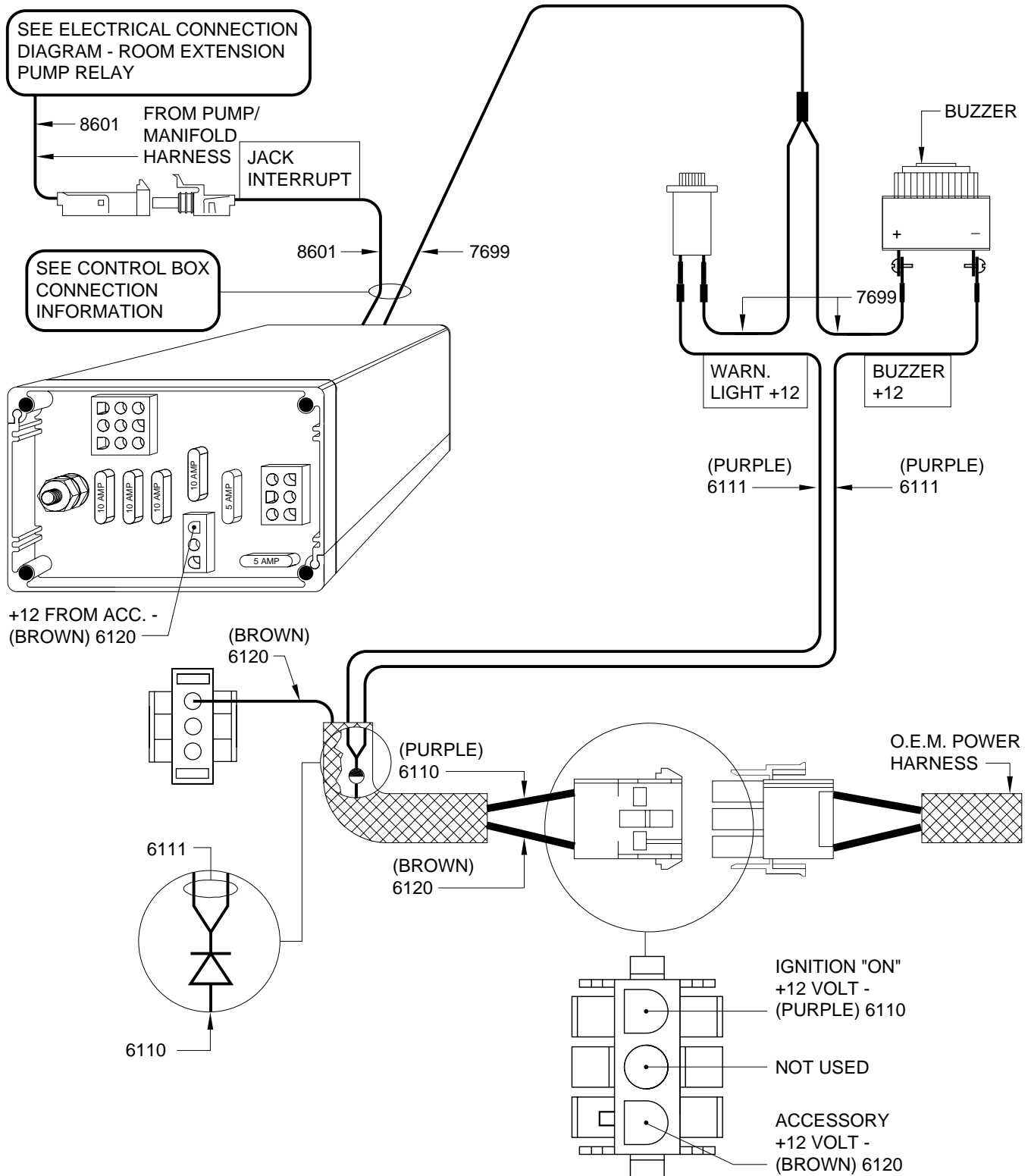

# ELECTRICAL CONNECTION DIAGRAM ROOM EXTENSION SYNCHRONIZING CYLINDER PRESSURE SWITCHES

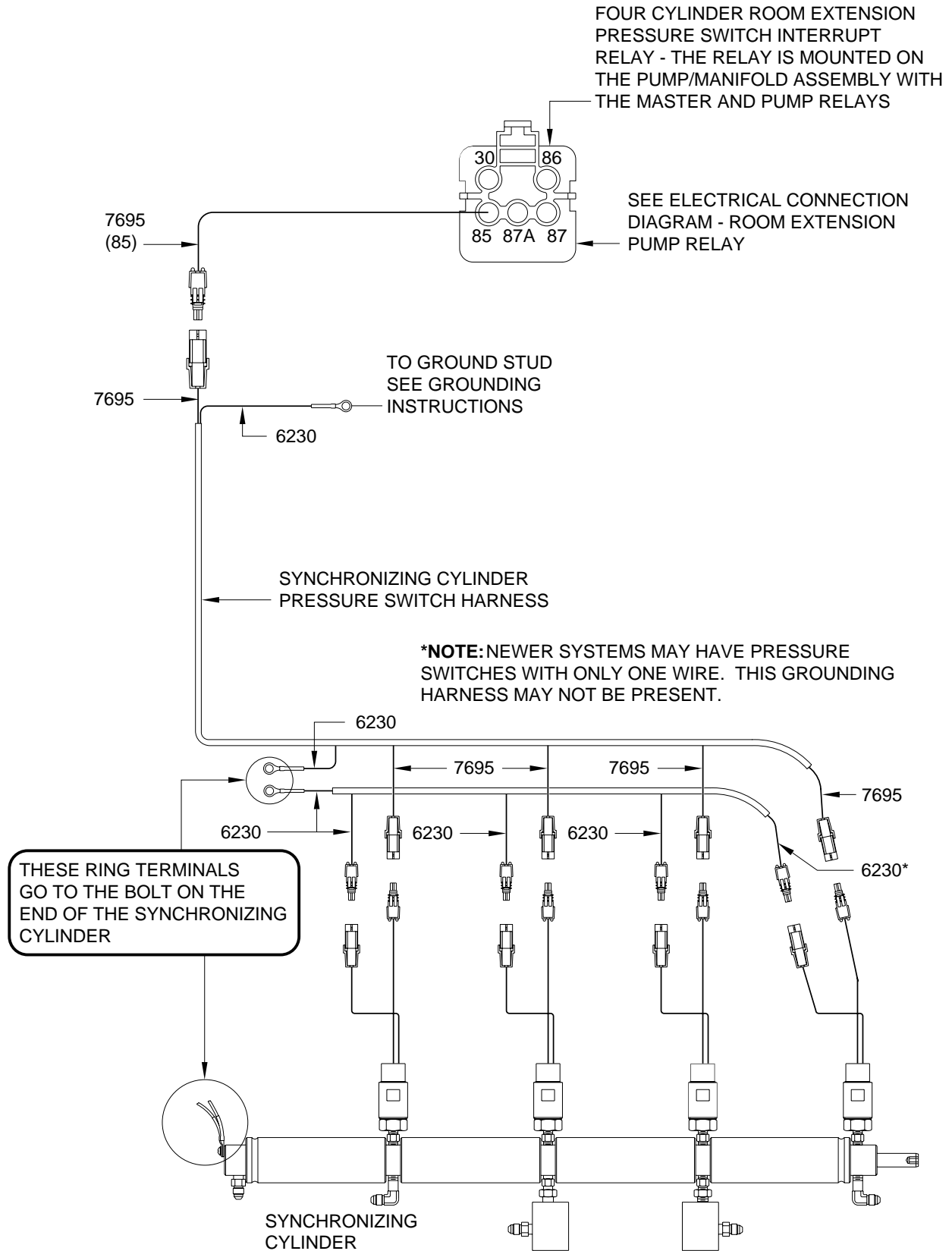

MP85.505G  
06DEC00

# GROUNDING INSTRUCTIONS

## 610 SERIES LEVELING SYSTEM WITH ROOM EXTENSION

### WELDED PUMP MOUNT

USING GROUNDING STUD AND 3/8" EXTERNAL STAR LOCKWASHERS AS SHOWN.

**IMPORTANT:** STAR LOCKWASHERS MUST BE USED BETWEEN GROUNDING SURFACE AND WIRE TERMINALS.

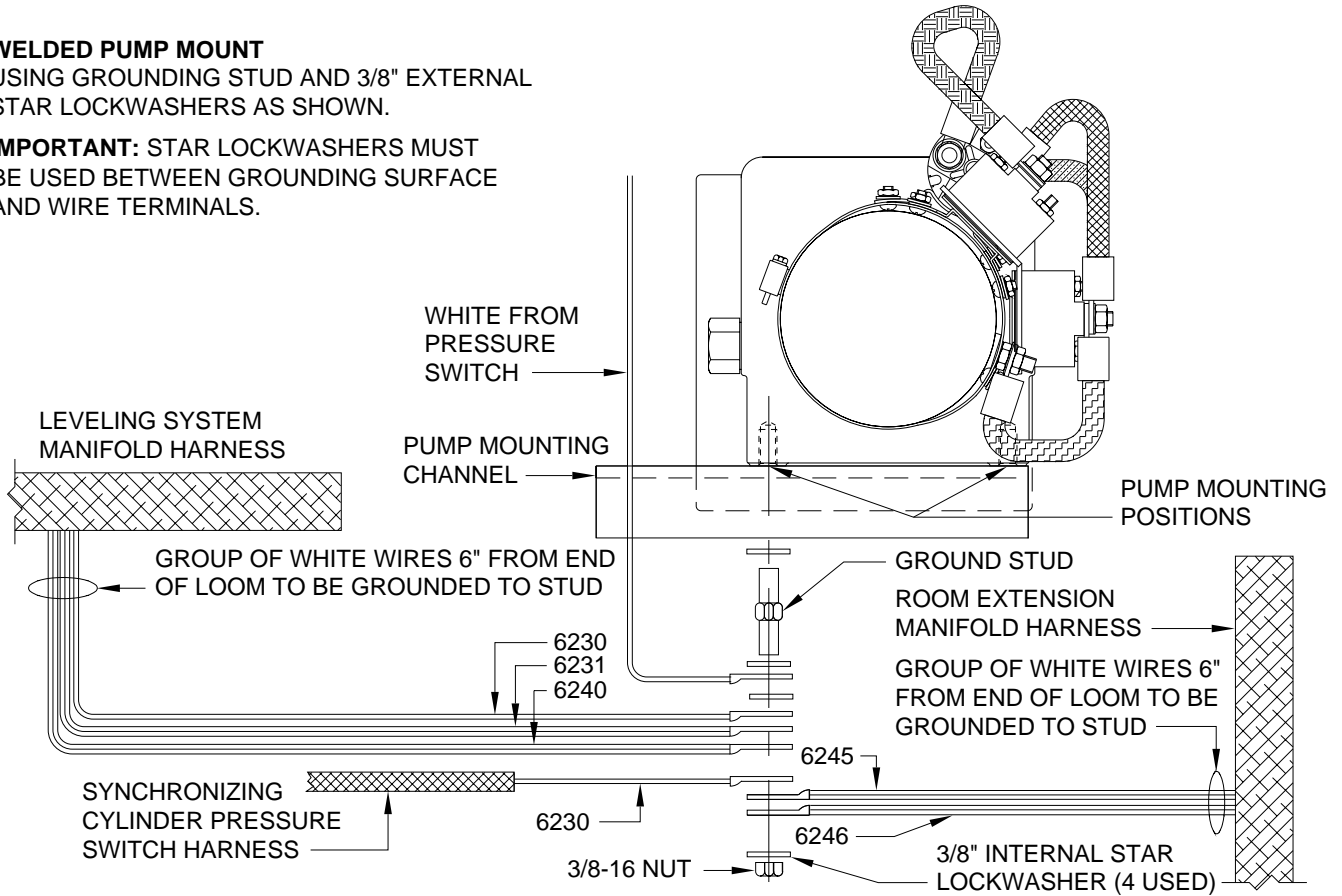

### PUMP MOUNTED REMOTE FROM FRAME

USE GROUNDING STUD AND 3/8" EXTERNAL STAR LOCKWASHERS AS SHOWN.

**IMPORTANT:** STAR LOCK WASHERS MUST BE USED BETWEEN GROUNDING SURFACE AND WIRE TERMINALS.

