

MANUAL JACK AND ROOM OPERATION WITH PUMP TOGGLE SWITCH

625 SERIES LEVELING SYSTEM - SPRING RETURN JACKS

3 - UNIVERSAL LEVEL OUT ROOM EXTENSIONS

WARNING!

READ AND UNDERSTAND OPERATOR'S MANUAL, INCLUDING ALL WARNINGS AND SPECIFIC OPERATING INSTRUCTIONS, BEFORE USING SOLENOID VALVE MANUAL RELEASE CAMS AND THE PUMP RUN TOGGLE SWITCH.

KEEP AWAY FROM WHEELS, DO NOT CRAWL UNDER THE VEHICLE, KEEP A SAFE. DISTANCE IN FRONT AND REAR OF THE VEHICLE. THE VEHICLE MAY DROP AND / OR MOVE FORWARD OR BACKWARD WITHOUT WARNING AS THE VALVE RELEASE IS OPERATED.

Operator's manuals available from HWH Corporation or at www.hwh.com.

EXTENDING JACKS

Locate the PUMP RUN toggle switch. Refer to the vehicle manufacturer. The pump has to run to extend jacks.

The pump should be running before valves are opened. If a valve is opened with the pump off, jacks can retract and the coach can drop.

Refer to the operator's manual for specific leveling procedures.

When jacks are extended as needed, close the valves then release the pump toggle switch.

IMPORTANT: DO NOT hold the pump toggle switch to "PUMP RUN" for more than 4 minutes without allowing the pump motor to cool.

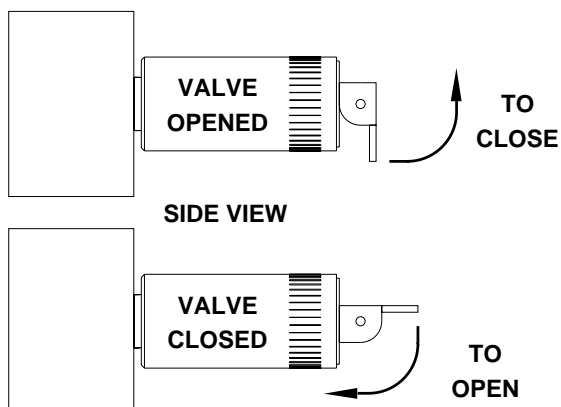
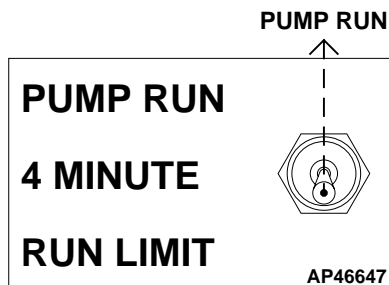

IMPORTANT: ONLY MOVE THE RELEASE CAM IN THE DIRECTION SHOWN. MOVING THE CAM IN THE OPPOSITE DIRECTION CAN DAMAGE THE VALVE.

RETRACTING JACKS

The pump CAN NOT be running when retracting the jacks.

To eliminate twisting of the vehicle, open both front jack valves, wait several seconds then open both rear jack valves.

When the jacks are fully retracted, close all jack valves.

DO NOT try to run room extensions while jacks are retracting. Running the pump while jacks are retracting will extend the jacks.

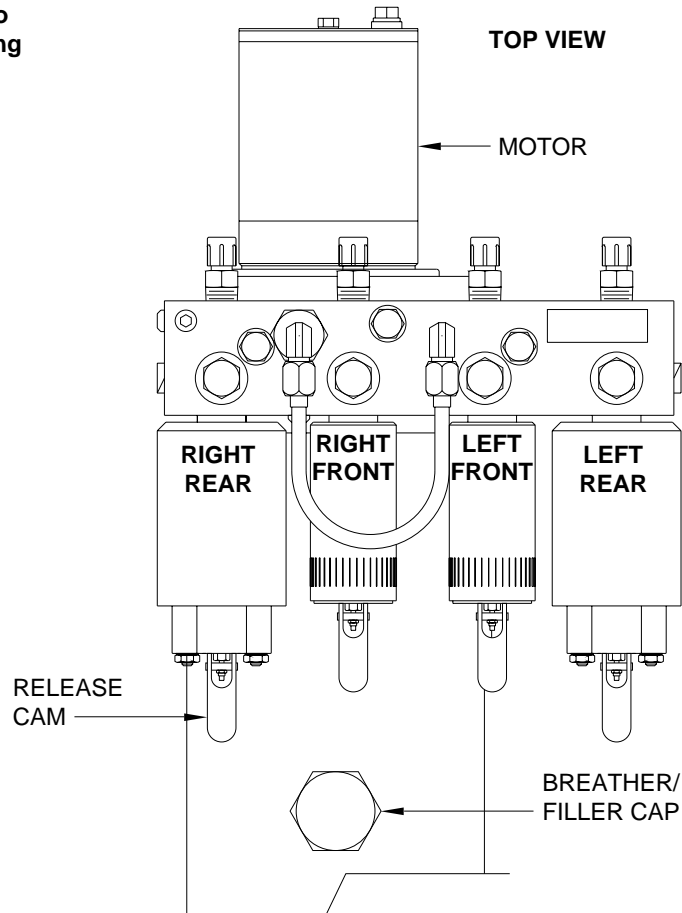

ROOM EXTENSION OR RETRACTION

WARNING: KEEP PEOPLE AND OBSTRUCTIONS CLEAR OF ROOM WHEN OPERATING. DO NOT OPERATE ROOM WITH ANY ROOM CLAMP, LATCHING DEVICE OR MANUAL RETRACTING DEVICE ATTACHED TO THE ROOM.

Locate the PUMP RUN toggle switch. The pump must run to extend or retract a room extension.

Make sure there is adequate clearance to fully extend a room.

Open the appropriate valve release cam to extend or retract the room. Only extend or retract one room at a time.

Push and hold the pump control toggle switch to pump run.

When the room is completely extended or retracted, close the valve release cam, then release the pump toggle switch.

IMPORTANT: DO NOT hold the pump toggle switch to PUMP RUN for more than 4 minutes without allowing the pump motor to cool.

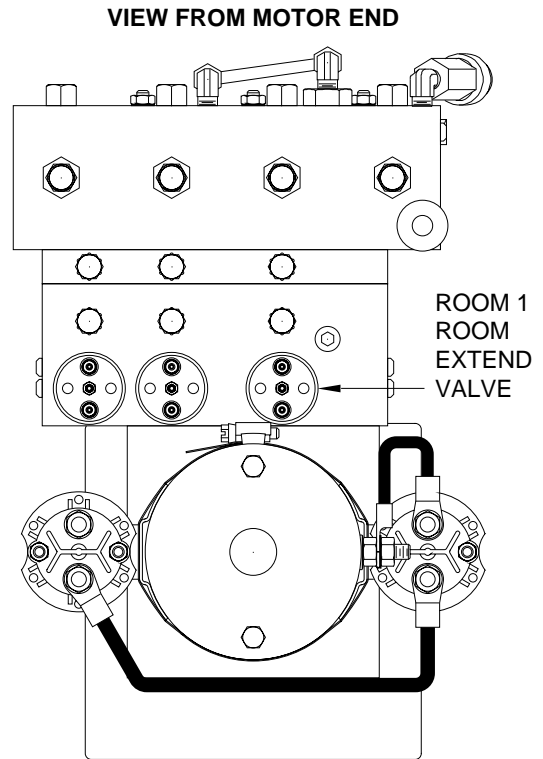
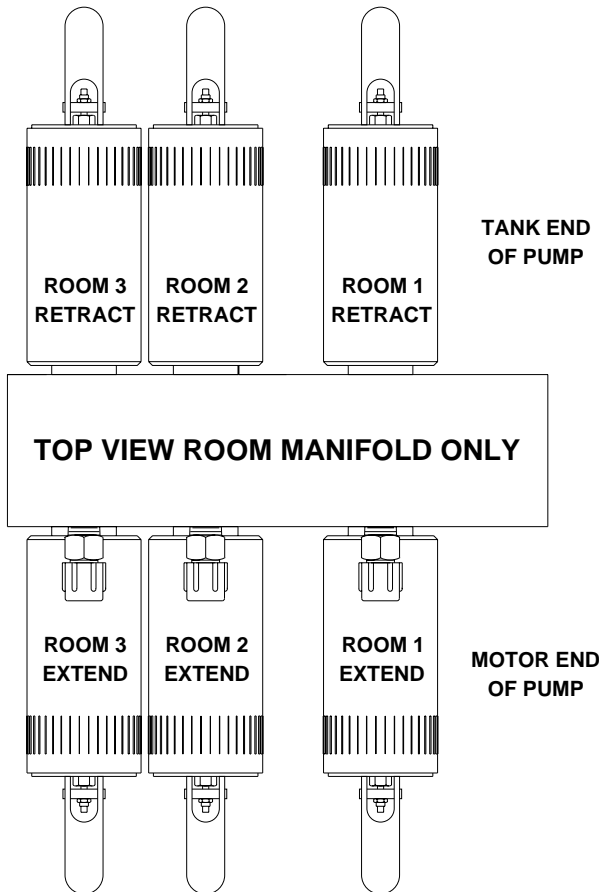

ROOM 1 - PASSENGER SIDE FRONT (OR PASSENGER SIDE)

ROOM 2 - PASSENGER SIDE REAR (OR DRIVER SIDE FRONT)

ROOM 3 - DRIVER SIDE (OR DRIVER SIDE REAR)

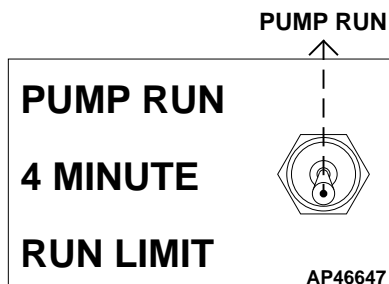
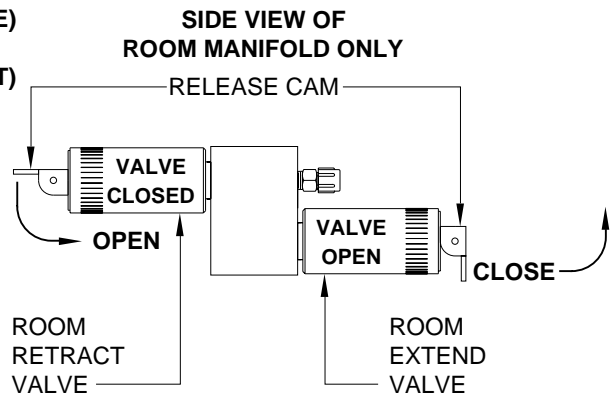

IMPORTANT: ONLY MOVE THE RELEASE CAM IN THE DIRECTION SHOWN. MOVING THE CAM IN THE OPPOSITE DIRECTION CAN DAMAGE THE VALVE.