



# SERVICE MANUAL

## HWH® COMPUTER-CONTROLLED 610 SERIES LEVELING SYSTEM

### FEATURING:

*Touch Panel Leveling Control*  
*Single Hose*  
*Hydraulic Leveling*  
*Three Wire Jack Warning Switches*  
*(Optional Air Dump)*

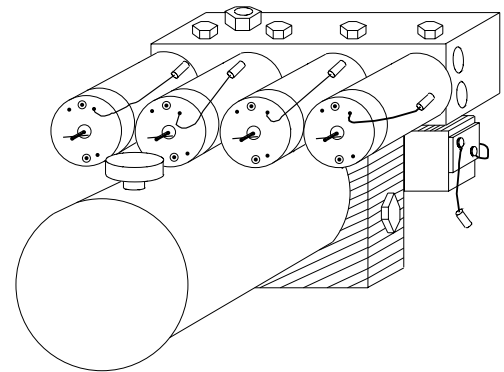
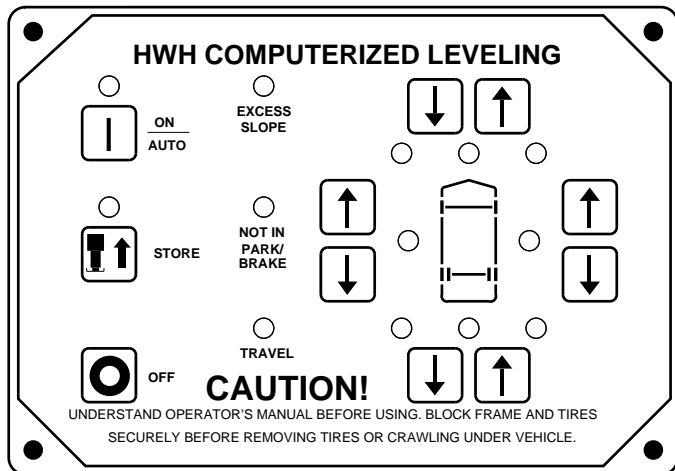

**HWH CORPORATION**  
(On I-80, Exit 267 South)  
2096 Moscow Road | Moscow, Iowa 52760  
Ph: 800/321-3494 (or) 563/724-3396 | Fax: 563/724-3408  
[www.hwh.com](http://www.hwh.com)

ML9138/MI91.0005  
06MAY04

## SECTION 1

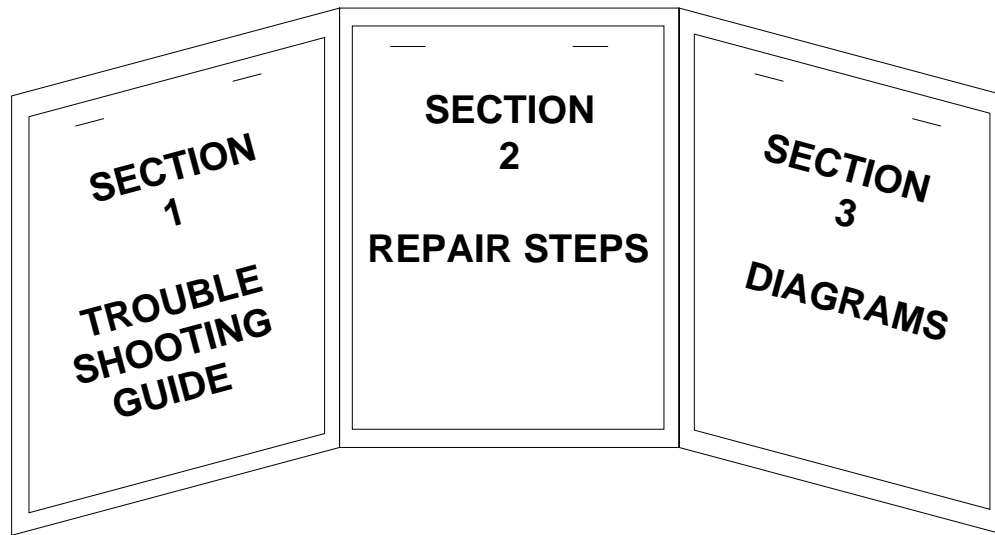

### 3 PART FOLDER

**IMPORTANT:** Proper grounding of system components is important for proper operation of the system. Poor grounds can cause erratic operation. If normal repair procedures have not corrected problems or if trouble shooting procedures in this manual do not correct problems, refer to the FIELD ENHANCEMENT procedures and diagrams at the rear of Section 2 of this manual.

## HOW TO USE MANUAL

This manual is written in three sections. Section 1 is the Trouble Shooting Guide. Section 2 is the Repair Steps. Section 3 is the Diagrams. Begin diagnosis of the system with Section 1, the Trouble Shooting Guide. This will give the correct operation and function of the system. When a malfunction is encountered, the Trouble Shooting Steps will direct you to the proper Repair Steps in Section 2, the Repair Steps. The Repair Steps are broken into 3 columns, Problem, Solution, and Diagram. In the proper part under Problems, find the symptom you have encountered. The testing and repair for that problem is in the Solution (center) column. Diagrams for a particular Problem and Solution are in the Diagram (right hand) column. This column will direct you to the proper diagram in Section 3, Diagrams, for a more detailed view.

Before beginning your repair it is **IMPORTANT** to read the **CAUTIONS** and **NOTES AND CHECKS** in the first section, **TROUBLE SHOOTING GUIDE**. In many cases this will save time and mistakes when trouble shooting a system.

This Repair Manual is offered as a guide only. It is impossible to anticipate every problem or combination of problems. This manual is written in sequential order of the proper operation of the system. The Trouble Shooting Steps must be followed in order to give correct diagnosis of the problem(s). For any problems encountered that are not addressed in this manual, contact HWH Corporation for assistance.

**PROCEED WITH TROUBLE SHOOTING GUIDE**



# TROUBLE SHOOTING

## WARNING!

**BLOCK FRAME AND TIRES SECURELY BEFORE CRAWLING UNDER VEHICLE. DO NOT USE THE LEVELING JACKS OR AIR SUSPENSION TO SUPPORT VEHICLE WHILE UNDER VEHICLE OR CHANGING TIRES. VEHICLE MAY DROP AND OR MOVE FORWARD OR BACKWARD WITHOUT WARNING CAUSING INJURY OR DEATH.**

**WHEN ROUTING OR REROUTING HYDRAULIC HOSES AND WIRES, BE SURE THEY ARE NOT EXPOSED TO ENGINE EXHAUST OR ANY HIGH TEMPERATURE COMPONENTS OF THE VEHICLE.**

**THE JACKS MAY ABRUPTLY SWING UP WHEN THE FOOT CLEARS THE GROUND OR WHEN THE JACK REACHES FULL EXTENSION.**

**NEVER PLACE HAND OR OTHER PARTS OF THE BODY NEAR HYDRAULIC LEAKS. OIL MAY CUT AND PENETRATE THE SKIN CAUSING INJURY OR DEATH.**

**SAFETY GLASSES ARE TO BE WORN TO PROTECT EYES FROM DIRT, METAL CHIPS, OIL LEAKS, ECT. FOLLOW ALL OTHER SHOP SAFETY PRACTICES.**

**DO NOT OVER EXTEND THE REAR JACKS. IF THE WEIGHT OF THE VEHICLE IS REMOVED FROM ONE OR BOTH REAR WHEELS, THE VEHICLE MAY ROLL FORWARD OR BACKWARD OFF THE JACKS.**

## NOTES AND CHECKS

Read and check before preceding with Trouble Shooting Steps.

**NOTE: HWH CORPORATION ASSUMES NO LIABILITY FOR DAMAGES OR INJURIES RESULTING FROM THE INSTALLATION OR REPAIR OF THIS PRODUCT.**

1. If the jacks cannot be retracted, see Trouble Shooting Step 12 for temporary measures. Make sure the manual retract valves are closed before trouble shooting.

2. The Trouble Shooting Guide must be followed in order. Problems checked for in one step are assumed correct and not checked again in following steps.

3. Check that the oil reservoir is full with the jacks in the fully retracted position.

4. Most vehicles have more than one battery; one for the engine and the other(s) for the vehicle. The engine battery supplies power for the control box and hydraulic pump. DO NOT use the vehicle batteries to supply power to the pump. Batteries should read 12.6 volts. Batteries must be in good condition with no weak cells. An alternator, converter, convertor, or battery charger will not supply enough power for the system to operate properly.

**NOTE:** Batteries and connections should be checked under load with the pump running.

5. The control box automatically monitors these batteries during the "AUTOMATIC LEVELING, RETRACT, AND MANUAL" modes of operation. The system will stop its operation and the "battery" symbol on the touch panel will light when either of the batteries voltages drops below 8.5-9.0 volts. Have the batteries properly charged to their full capacity. If a replacement control box is used, the battery symbol will not work.

6. Proper ground of all components is critical. See the electrical circuit for specific grounds required. Faulty grounds, especially for the control box, solenoid manifold or the pump

assembly, may cause control box component damage and/or improper or erratic operation.

7. Do not replace the control box unless the Repair Steps say to replace it. Otherwise the malfunctions may damage the new control box.

**This manual is intended for use by experienced mechanics with knowledge of hydraulic and automotive electrical systems. People with little or no experience with HWH leveling systems should contact HWH technical service at 1-800-321-3494 before beginning. Special attention should be given to all cautions, wiring, and hydraulic diagrams.**

**Special note: When installing a new control box, make sure the box is properly grounded before applying power to the system.**

**Tightening of hose ends: If tightening a new hose end, make the hose end snug (finger tight) on the fitting, then tighten the hose end 1/3 turn (2 FLATS). If tightening an existing hose end, tighten the hose end to snug plus 1/4 turn (1 FLAT).**

Suggested tools for trouble shooting the HWH leveling systems:  
JUMPER WIRES(UP TO 10 GAUGE)  
PRESSURE GAUGE(3500 PSI MIN.)  
MULTI-METER  
12 VOLT TEST LIGHT

**PROCEED WITH THE TROUBLE SHOOTING STEPS ON THE FOLLOWING PAGE**



# TROUBLE SHOOTING STEPS

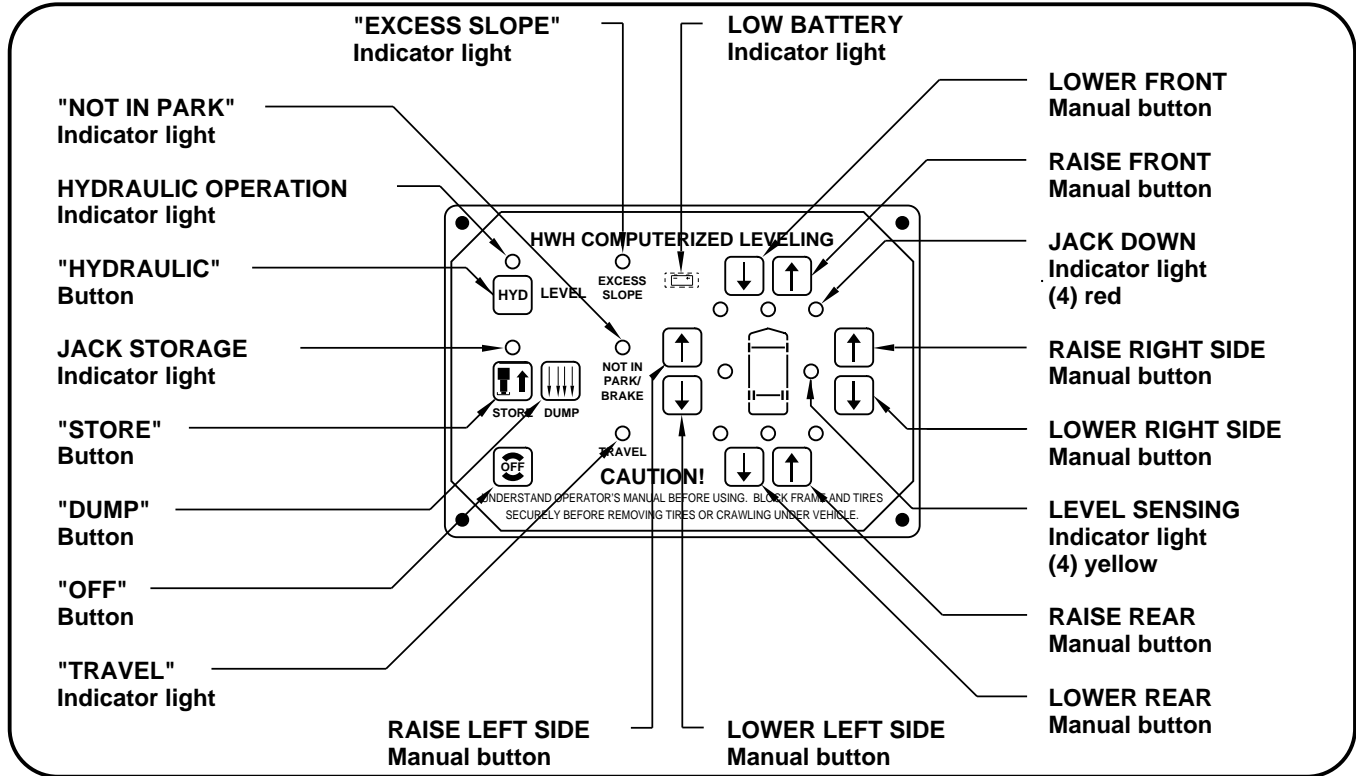

1. Make sure the transmission is in the recommended position for parking and the park brake is set. With the ignition switch off, there should not be any power to the leveling system. If any touch panel lights are on, see Part 1 of the Repair Steps.

2. Turn the ignition switch to "ON" or "ACC". Only the green travel light should be lit at this time. If this is not so, see Part 2 of the Repair Steps.

3. Push the "I" button one time. The red indicator light above the "I" button should glow steady. One or two yellow level indicator lights may be on. The green travel light will still be on. The "NOT IN PARK/BRAKE" light should not be lit. The pump should not run. If this is not so, see Part 3 of the Repair Steps.

**NOTE:** If the vehicle is equipped with Straight-Acting jacks, proceed to STEP 5.

4. Push the "I" button a second time. The red light above the "I" button should start to flash. The pump should come on and the jacks should go vertical. The left front first, the right front second, the right rear third and finally the left rear. The four red warning lights should be lit. The master warning light on the dash should be lit. The red light above the "I" button will glow steady. If any of this sequence does not happen, see Part 4 of the Repair Steps.

**NOTE:** The vertical operation is a progressive function. As each jack is swinging vertical the microprocessor is looking for a warning switch, a three second background timer, or a jack pressure switch. A jack can extend and start to lift the vehicle if that warning switch is not working properly. Jack warning switches and pressure switches must work properly for the system to function in the automatic mode.

5. With the jacks in the vertical position, the operator can manually operate the jacks with the eight buttons on the right half of the touch panel. The up arrows will lift the vehicle by extending the jacks; whereas, the down arrows will lower the vehicle by retracting the jacks. The jacks operate in pairs; left side, right side, front, and rear. Press the up arrow button for each jack pair, checking that the proper pair of jacks operate. Press the down arrows to make sure the jacks will retract properly. If any part of this function does not work properly, see Part 5 of the Repair Steps.

**Vehicles with Straight-Acting jacks:** If the Low Battery Indicator light comes ON, see Part 4b of the REPAIR STEPS. If the pump will not run see Part 4c of the REPAIR STEPS. If the pump runs under no load and nothing happens, see Part 4d of the REPAIR STEPS. If a warning light for a jack will not come ON when a jack has extended 1 to 2 inches, see Part 4e of the REPAIR STEPS. If a jack will not stay extended, see Part 4i of the REPAIR STEPS. Straight-Acting jacks do not have actuators.

---

## TROUBLE SHOOTING STEPS (CONT'D)

---

6. Air dump test for vehicles with the air dump option. The Air Dump button will work either with the Leveling System OFF and the ignition ON or with the Leveling System OFF and the jacks in the vertical position. There should be one air dump valve for each height control valve. If the air dump valves are equipped with emergency shutoff valves, make sure they are open. With the system OFF, the ignition ON and the engine running, push the dump button. The air should dump from the suspension while the dump button is being pushed. When the dump button is released, the air should stop dumping and the vehicle should return to proper ride height. Again with the engine running, push the "I" button. The air dump button should not work at this time. Push the "I" button again so that the jacks are vertical. Now the air dump button should work. Air will dump from the system while the button is depressed and stop dumping when released. The vehicle should now return to the proper ride height. If this does not function properly, see Part 6 of the REPAIR STEPS.

7. Sensing unit check. Put the jacks in the vertical position. If the vehicle is equipped with air dump, dump the air at this time.

Using a bubble level inside the vehicle, level the vehicle using the buttons on the right side of the panel as described in Part 5. All yellow level indicators should be off at this time, if not the sensing unit may need to be adjusted.

When a yellow light is on it indicates that side or end of the vehicle is low according to the sensing unit. Check also that all lights can be made to come on (at different times) by retracting its jack pair and or extending the opposing jack pair. If the ground is sloping or uneven, the vehicle may need to be moved to complete the test. For sensor adjustment procedures, see Part 7 of the REPAIR STEPS.

**At this time, manually retract all the jacks to their fully stored position. From this point on, it is assumed the system is fully functional in the manual mode. Whenever a malfunction occurs, revert to the manual operation and check for correct functioning. If a problem is found in the manual operation, trouble shoot the problem using the preceding steps. Remember, low volts can cause erratic performance and damage components.**

## AUTOMATIC LEVELING

8. Turn the ignition switch to the "ON" or "ACC" position. For vehicles with automatic air dump, the engine must be off during leveling. Press the "I" button. The red indicator light above the "I" button will be lit. Set the park brake if the "NOT IN PARK/ BRAKE" light is on. If the vehicle is equipped with Straight-Acting jacks, proceed to Step 9. Press the "I" button a second time. This will put the jacks in the vertical position. The following should occur:

- A. The red indicator light above the "I" button should start to flash.
- B. The pump should start.
- C. The jacks will progressively swing to the vertical position.
- D. Each red warning light on the touch panel will come on as its jack becomes vertical.
- E. The master warning light will be on.
- F. The pump will shut off as the last red warning light comes on.
- G. The red indicator above the "I" button will glow steady.

The above portion of the automatic leveling was covered in Parts 1 through 4 of this Section. Refer to Parts 1 through 4 for any malfunction that occurs at this time.

9. Press the "I" button the third time (second time with Straight-Acting jacks). The following should automatically occur:

- A. The red indicator light above the "I" button will start to flash.

B. Vehicles equipped with automatic air dump will dump the air at this time. The system will dump air for approximately 25 to 30 seconds before continuing. The dump valves will remain open until the leveling system has automatically shut itself off.

C. One, two, or three jacks at a time will extend corresponding to any yellow lights which are lit. This will continue until all yellow level indicator lights are out or until one or two jacks have reached their full extension.

**NOTE:** The appropriate red warning light will come ON as a Straight-Acting jack extends 1 to 2 inches.

D. After a pause, the pump will come on and run until all remaining jacks not touching the ground, extend to the ground to stabilize the vehicle. Through a pressure switch on each jack, the control box automatically senses when each jack is firmly on the ground. The computer constantly rechecks all the jack pressure switches and will return to any jack that has lost its pressure switch signal until all four jacks have reached the minimum stabilize pressure. Jacks used to stabilize the vehicle should lift the vehicle a minimum of 1/2 inch.

**NOTE:** Same control boxes have different leveling, stabilizing and excess slope programs. Contact HWH Customer Service for assistance.

E. The red indicator light above the "I" button will stop flashing, the red indicator light will go out as the system shuts off. If any of the above does not function properly, see Part 9 of the REPAIR STEPS.

## TROUBLE SHOOTING STEPS (CONT'D)

### RETRACT PROCEDURE

10. For systems with automatic air dump, start the vehicle engine to build up air pressure and leave it running. If the dump valves are not closed, see Part 6 of this Section.

11. Push the "I" button one time. The red indicator light above the "I" button will glow steady. The pump should NOT be running. Push "STORE" button. The following should occur:

- A. The red indicator light above the "STORE" button should start to flash.
- B. The jacks should start to retract to the store position.
- C. The red warning lights on the touch panel should go out as the jacks return to the store position.
- D. The master warning light should go out.
- E. The green "TRAVEL" light should come on.
- F. The red indicator light above the "STORE" button will stop flashing and the computer will automatically shut the system off. The only light that should be lit on the touch panel will be the "TRAVEL" light. If any of the above does not occur, see Part 11, Trouble Shooting Section.

**NOTE:** The system will automatically retract for 6 minutes after the last red warning light goes out, unless 1 or more red warning lights stay lit. If a warning light stays lit, the system will continue to retract for 30 minutes and then shut down regardless of any lit warning lights.

**CAUTION:** UNLESS TROUBLE SHOOTING, THE LEVELING SYSTEM MUST BE ALLOWED TO RETRACT THE FULL 6 MINUTES BEFORE INTERRUPTING POWER TO THE COMPUTER.

12. EMERGENCY JACK RETRACTION: Each solenoid valve is equipped with a T-handle release valve. Turn the handle counterclockwise approximately 3 turns or until the jack starts to retract. The oil will return to the reservoir and the jack should retract to the store position. After all the jacks are fully retracted, turn the T-handle clockwise until snug.

If no jacks will retract, the problem is the shuttle valve. Remove and reassemble any one check valve cap (SEE MP65.0). The system should now retract the jacks. If not, call HWH Customer Service for assistance.

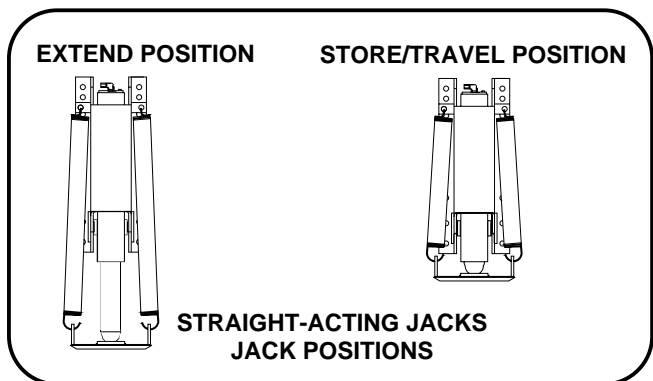
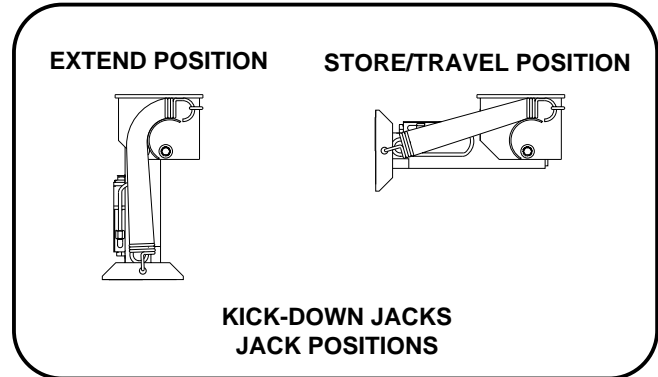

## **SECTION 2**

# **REPAIR MANUAL**

## **HWH COMPUTERIZED LEVELING SYSTEM 610 SERIES**

**FEATURING:  
TOUCH PANEL CONTROL  
SINGLE HOSE**

**BEGIN WITH SECTION 1**

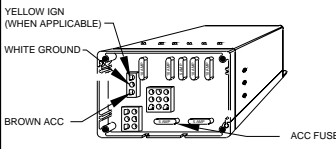
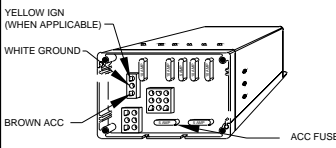
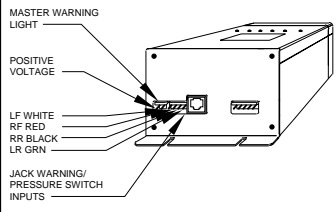

# REPAIR STEPS

PROBLEM	SOLUTION	DIAGRAMS
<p><b>Part 1</b>  <b>Touch panel has indicator lights on with the ignition switch off.</b></p>	<p>There should be no +12 power to the 7" control box. Trace the brown or yellow wire in the 3 pin UML connector to its source. The wire should be connected to accessory or ignition power. (Accessory power is preferred.)</p>	 <p style="text-align: center;"><b>REFER TO MP85.5043</b></p>
<p><b>Part 2</b>  <b>With the ignition switch on:</b></p> <p>a. The green "TRAVEL" light nor the master "JACKS DOWN" warning light is lit.</p>	<p>With the ignition switch on, the brown (or yellow) wire in the 3 pin UML connector should have +12 power. If not, trace the wire to its source. Check any in-line fuses. If +12 power is present, check the 5 amp ACC fuse on the 7" control box. Check that the white wire in the 3 pin UML connector is properly grounded. Check that the modular cable is correctly plugged into the touch panel. If it is ok, the problem is the 7" control box.</p>	 <p style="text-align: center;"><b>REFER TO MP85.5043</b></p>
<p>b. The master "JACKS DOWN" warning light is on. (Jacks are all in the stored position.)</p>	<p>Push the "I" button one time. A red jacks down warning light on the touch panel should come on, indicating a jack is down. Unplug the jack pressure switch. If the red warning light goes out, the switch is stuck and should be replaced. If not, unplug the jacks warning switch. If the red warning light still does not go out, unplug the 4 wire MTA connector for the warning switches at the 7" control box. If the red warning light goes out, the wire to the jack warning switch is shorted to ground. If the red warning light stays on, replace the 7" control box.</p> <p>If no red warning light on the touch panel comes on, check the wires to the master warning light. If the wires are ok, replace the 7" control box.</p>	<p style="text-align: center;"><b>REFER TO MP85.5110</b>  <b>REFER TO MP85.5115</b>  <b>REFER TO MP85.5120</b></p>  <p style="text-align: center;"><b>REFER TO MP85.5043</b></p>
<p>c. The touch panel has indicator lights on other than the green "TRAVEL" indicator.</p>	<p>Turn the ignition switch off then back on. If the lights do not go out, the 7" control box or the touch panel, is the problem.</p>	

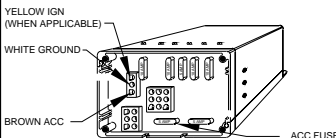
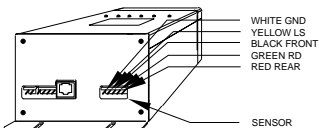
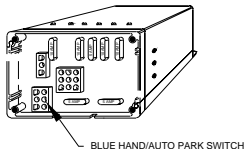
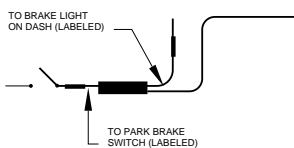
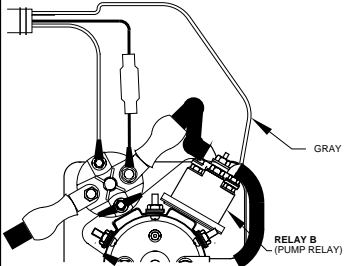

# REPAIR STEPS

PROBLEM	SOLUTION	DIAGRAMS
<p><b>Part 3</b> After pushing the "I" button one time:</p> <p>a. The red indicator light above the "I" button does not come on.</p>	<p>Check power to the control box on the brown or yellow wire in the 3 pin UML. Check the white wire in the 3 pin UML for a proper ground. Check the 5 amp fuse in the 7" control box. If this is ok, the 7" control box, the touch panel, or the modular cable is the problem.</p>	 <p style="text-align: center;"><b>REFER TO MP85.5043</b></p>
<p>b. More than two yellow lights are lit or opposite yellow lights are lit.</p>	<p>Unplug the sensing unit MTA connector from the 7" control box. If the lights DO NOT go out, replace the control box. If the lights go out, connect a 12 volt test light to ground. Touch each of the four pins for the sensing unit. Only one light per pin should come on. Connect the test light to +12 and check the ground pin. If the sensing unit pins in the control box function correctly, replace the sensing unit. If not, replace the control box.</p>	 <p style="text-align: center;"><b>REFER TO MP85.5043</b></p>
<p>c. The "NOT IN PARK/BRAKE" light is lit.</p>	<p>Check that the transmission is in the proper park position and that the park brake is set. Some park brakes automatically set when the transmission is placed in park. Trace the blue wire in the 6 pin UML connector to its source. Check for the proper position of the diode arrangement. Check the brake switch for proper function. <b>NOTE:</b> Most coaches complete a ground signal through the brake switch, but some do have +12 signal. Make sure the proper box is being used. Use a jumper wire to apply the proper signal to the blue wire. If the "NOT IN PARK/BRAKE" light does not go out, replace the control box.</p>	 <p style="text-align: center;"><b>REFER TO MP85.5043</b></p>  <p style="text-align: center;"><b>REFER TO MP85.5046</b></p>
<p>d. The pump comes on at this time.</p>	<p>If possible, release the park brake. If the pump continues to run replace Relay B. Otherwise, check Terminal 5 with a 12 volt test light connected to ground. If +12 volts is present, the problem is with the control box. If +12 is NOT present, replace Relay B.</p>	 <p style="text-align: center;"><b>REFER TO MP85.5060</b></p>
<p><b>Part 4</b> After pushing the "I" button a second time:</p> <p>a. The red indicator light above the "I" button does not flash.</p>	<p>Push the "OFF" button, then the "I" button twice. If the light still does not flash, replace the control box.</p>	

# REPAIR STEPS

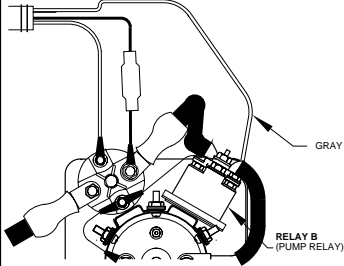
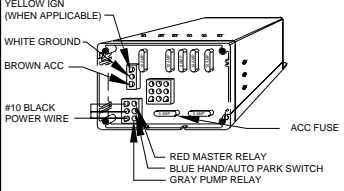
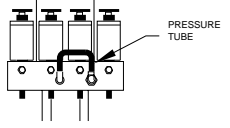
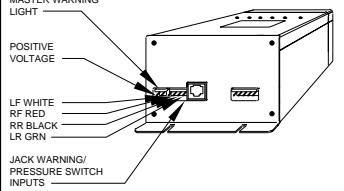
PROBLEM	SOLUTION	DIAGRAMS
<p><b>Part 4 cont'd.</b></p> <p>b. The low battery indicator light comes on.</p>	<p>Push the "OFF" button, then the "I" button one time. Check that Terminal 8, Relay A, is properly grounded. Terminals 1, 2 and 3 should all have +12 volts. Terminal 2 is the main power supply from the batteries. Check batteries, connections, battery grounds etc. if +12 is not present on Terminal 2. If Terminal 1 has +12 but not Terminal 3, replace Relay A. If Terminal 1 does NOT have +12, check the 5 amp ACC fuse. If the fuse is ok, check the red wire in the 6 pin UML at the control box. If +12 is present at the control box, the problem is the red wire. If +12 is not present at the control box, replace the control box. If the fuse is blown, the problem may be a shorted red wire or a bad master relay. If Terminals 1, 2 and 3 all have power, check the three black wires in the 6 pin UML at the control box. (This must be checked while the 6 pin UML is plugged into the control box.) If +12 is not present, the #10 black wire is broken or the 60 amp fuse on the #10 black wire at the relay is blown. If +12 is present on the black wire, check the voltage on the black wire at the control box while the "I" button is pushed a second time. Voltage is also monitored on the brown (or yellow) wire in the 3 pin UML connector. If the voltage drops below 8.5 to 9.0 volts, the low volts indicator will come on. The problem could be a bad battery, a bad pump motor, loose connection or bad wires. If the voltage does NOT drop, replace the control box.</p>	 <p style="text-align: center;"><b>REFER TO MP85.5060</b></p>
<p>c. The pump does not come on.</p>	<p>After pushing the "I" button the second time, if the pump does not run, the indicator light above the "I" button will flash approximately 12 seconds. The system then shuts down. The light must be flashing to make the following checks. Check that Terminal 7 of Relay B is properly grounded. Check for +12 volts on Terminals 5 and 6 of Relay B. If +12 is present on Terminal 5 but not 6 replace Relay B. If +12 is present on both 5 and 6, the pump is the problem. Check that the pump is securely mounted and grounded to the frame of the vehicle. If +12 is NOT present on Terminal 5, check the 5 amp pump fuse. If the fuse is not blown and +12 is not present on the gray wire in the 6 pin UML at the box, replace the control box. If +12 is present at the control box, the problem is the gray wire. If the fuse is shorted to ground or the pump relay is bad.</p>	 <p style="text-align: center;"><b>REFER TO MP85.5043</b></p>
<p>d. Pump runs under no load and nothing happens.</p>	<p>Disconnect the pressure tube between the manifold and shuttle valve. Connect the pressure gauge to the fitting in the manifold. (Not the shuttle valve.) Turn the pump on for 5 to 10 seconds. The pressure should be approximately 3500 psi. If there is low pressure, change the power unit. If the pressure is ok, change the shuttle valve.</p>	 <p style="text-align: center;"><b>REFER TO MP65.0</b></p>
<p>e. A jack is vertical but its red warning light is not lit.</p>	<p>Check that each jack has the proper color coded wire to its warning switch. If so, unplug the jack warning switch for the light not lit. Ground the wire going to the control box. If the light comes on, check the ground for the warning switch, then replace the switch. If the light does NOT come on, unplug the orange MTA connector for the warning switches at the control box. Use a 12 volt test light connected to ground. Touch each pin in the control box. If the red warning lights work properly, the signal wire from the jack is bad. If the red lights do NOT come on, replace the control box.</p>	<p style="text-align: center;"><b>REFER TO MP85.5110</b> <b>REFER TO MP85.5115</b> <b>REFER TO MP85.5120</b></p>  <p style="text-align: center;"><b>REFER TO MP85.5043</b></p>

# REPAIR STEPS

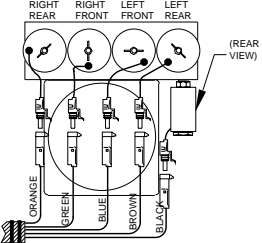
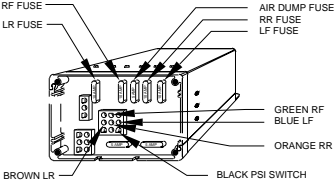
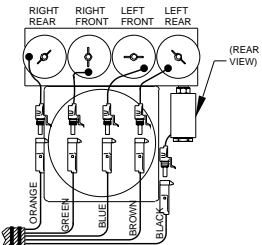
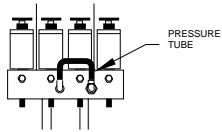
PROBLEM	SOLUTION	DIAGRAMS
<p><b>Part 4 cont'd.</b></p> <p>f. A jack is vertical but has extended the foot of the jack to the ground.</p>	<p>The computer did not see the warning switch when the jack swung vertical. The red light is on because the pressure switch tripped after the jack touched the ground not because the warning switch tripped. Refer to Part 4e to check the jack warning switches.</p>	 <p><b>REFER TO MP85.5067</b></p>
<p>g. A jack is not vertical nor is its red light on. The jack has not extended in the horizontal position.</p>	<p>On a new installation or after a repair, there could be air in the lines. Turn the system off and retry several times. If there is no change, then the problem is either a bad solenoid valve or control box. Check the 10 amp fuse for the malfunctioning jack. If the problem is a rear jack, interchange the wires for the rear solenoids. Retract and try the vertical mode again. If the problem stays with the same jack, change the solenoid valve for that jack. If the problem follows the wire, change the control box.</p>	 <p><b>REFER TO MP85.5043</b></p>
<p>h. A jack has extended in the horizontal position.</p>	<p>Check that the roller bearing or actuator cable is ok. Check that the hat stop is ok and adjusted properly. If these parts are ok, the problem is in the actuator and it should be replaced.</p>	<p><b>REFER TO MP85.5110</b>  <b>REFER TO MP85.5115</b>  <b>REFER TO MP85.5120</b></p>
<p>i. After going vertical, a jack returns to the horizontal position after the pump shuts off.</p>	<p>Push the "OFF" button. Push the "I" button twice. As the problem jack goes vertical and its red light comes on, push the "OFF" button. If the jack stays vertical, the control box is the problem. If the jack retracts, the problem is the solenoid valve or the actuator. Check that the emergency release valve on the solenoid valve is closed tight. Push the "I" button twice. Push the raise manual button that will operate that jack. Hold the button until the jack kicks vertical and extends and lifts the coach. Release the button. If the jack retracts, replace the solenoid valve for that jack. If it does NOT retract, the problem is probably the actuator on that jack.</p>	 <p><b>REFER TO MP85.5067</b></p>
<p><b>Part 5</b></p> <p>a. A jack extends but will not lift the coach.</p>	<p>Disconnect the tube between the shuttle valve and the manifold. Connect the pressure gauge to the fitting in the manifold. Check the pump pressure. It should be approximately 3500 psi. If the pump pressure is ok, replace the shuttle valve.</p>	 <p><b>REFER TO MP65.0</b></p>
<p>b. A jack will not retract.</p>	<p>For a 9000# jack, bleed pressure off between the jack and the actuator. If the jack will not retract, replace the jack. If the jack starts to retract, tighten the actuator tube and bleed pressure off between the actuator and the hydraulic supply line. If the jack does not retract, replace the actuator. If the jack starts to retract, then the problem is the solenoid valve for that jack or a kinked hose to the jack. For 6000# or 16000# jacks, bleed pressure between the actuator and the hydraulic supply line. If the jack does not retract, replace the jack. If the jack does retract, the problem is the solenoid valve for that jack or a kinked hose to the jack. <b>If none of the jacks will retract,</b> the shuttle valve is stuck and should be replaced.</p>	<p><b>REFER TO MP85.5110</b>  <b>REFER TO MP85.5115</b>  <b>REFER TO MP85.5120</b></p>

# REPAIR STEPS

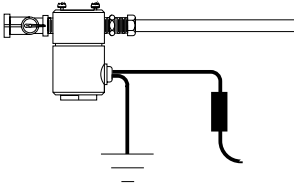
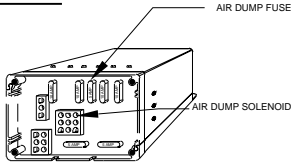
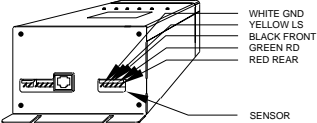
PROBLEM	SOLUTION	DIAGRAMS
<p><b>Part 6</b></p> <p>a. Air will not dump from the suspension.</p>	<p>With the leveling system off and the ignition on, check the wire going to the air dump valves for +12 volts while the dump button is being pushed. If +12 volts is present, check the ground for the valve then replace the valve. If +12 volts is not present, check the 5 amp air dump fuse. If the fuse is blown, the dump valve wire or one of the dump valves is shorted to ground. If the fuse is not blown, check for +12 volts on the gray wire in the 9 pin UML connector at the control box. If +12 is not present replace the control box. <b>NOTE:</b> Some air dump valves are equipped with an emergency shut off valve. Make sure this valve is open.</p>	 <p style="text-align: center;"><b>REFER TO MP75.5010</b></p>
<p>b. Air dump valves will not close.</p>	<p>With the ignition on, check the gray wire in the 9 pin UML connector at the box. If +12 volts is present, replace the control box. If +12 volts is not present, replace the air dump valve.</p>	 <p style="text-align: center;"><b>REFER TO MP85.5043</b></p>
<p><b>Part 7</b></p> <p><b>Yellow level indicator lights do not work properly.</b></p>	<p>The sensing unit is a 4 inch diameter disk that is usually mounted on the under side of the coach towards the middle of the coach. Occasionally it will be found inside the coach or in a storage compartment. Check that the unit is not mounted, nor the wires routed near a heat source. Check that the sensing unit is mounted correctly according to the sticker on the sensing unit. The sensing unit is adjusted by drawing up the corresponding screws (if the sensing unit is mounted under the coach) to put out the yellow lights. Unplug the sensing unit at the control box. Using a 12 volt test light connected to ground, touch each pin in the control box for the sensing unit. Check that the proper yellow light on the touch panel comes on when its pin is touched. Only one light should light when a pin is touched. Connect the test light to a +12 source. Check that there is a ground on the ground pin for the sensing unit. If there is a malfunction here, replace the control box. If the control box is ok, replace the sensing unit. Remember to keep the sensing unit away from any heat source.</p>	<p style="text-align: center;"><b>REFER TO MP85.5092</b></p>  <p style="text-align: center;"><b>REFER TO MP85.5043</b></p>
<p><b>Part 8</b></p> <p><b>The first part of automatic leveling was covered in Part 1 through 4 of this Section.</b></p>	<p><b>AUTOMATIC LEVELING</b></p>	
<p><b>Part 9</b></p> <p><b>After pushing the "I" button a third time:</b></p> <p>a. The red indicator light does not flash.</p>	<p>If the low volts indicator comes on recheck Part 4b of the Section. If the low volts indicator does not come on the problem is the touch panel or the control box.</p>	
<p>b. The air does not dump at this time. (If applicable.)</p>	<p>Recheck Part 6a of this Section. If the air will dump manually but not automatically, replace the control box.</p>	

# REPAIR STEPS

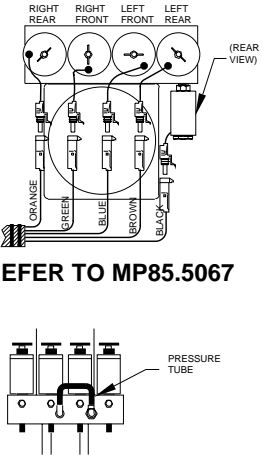
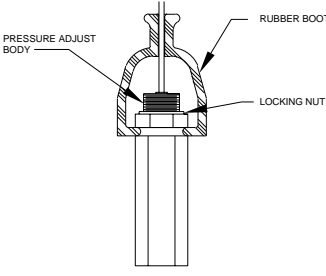
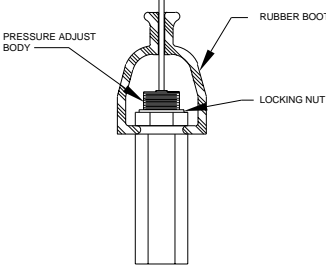
PROBLEM	SOLUTION	DIAGRAMS
<p><b>Part 9 cont'd.</b></p> <p>c. The coach will not level correctly according to the yellow indicator lights or the excess slope light comes on.</p>	<p>It is assumed at this point, wiring and hose routings have been checked and are ok. It is also assumed the sensing unit is functioning properly. Recheck the manual operation of the system. If the excess slope light is coming on and a jack has not reached full extension, unplug the wires to the pressure switch on the manifold and retry. If it now works, replace the pressure switch. If not, replace the control box. If the excess slope light will not come on when a jack reaches full extension, disconnect the tube between the shuttle valve and the manifold. Check the pump pressure. If the pump pressure is ok, retry and short the wires to the pressure switch together. If the excess slope light comes on, replace the pressure switch. If the light does not come on, replace the control box. During the leveling process, at no time should any jack retract. If the coach or a corner or the coach seems to drop a jack or is retracting while the pump is running, the problem is an internal check valve. Contact HWH CORPORATION, at 1-800-321-3494, for the proper repair procedure.</p>	 <p><b>REFER TO MP85.5067</b></p> <p><b>REFER TO MP65.0</b></p>
<p>d. All four jacks are not firmly stabilizing the coach.</p>	<p><b>IMPORTANT:</b> With some control boxes both front jack pressure switches have to be made or both front jacks will continue to extend during the stabilize mode. Check with HWH for the correct operation of a particular control box.</p> <p>The jack pressure switch(es) for the jack(s) not stabilizing have closed too soon. The jack pressure switches are adjustable. Loosen the locknut on the switch and turn the threaded plastic body clockwise 1/4 turn and recheck. Continue this process until the desired stabilizing effect is reached. The jacks used to stabilize should lift the coach a minimum of 1/2 inch.</p> <p>If adjusting the switch does not help, unplug the switch and retry if the jack now extends to the ground, replace the jack pressure switch. If the jack does not extend with the pressure switch unplugged, retry in the manual mode. If the jack extends manually, refer to the FIELD ENHANCEMENT pages at the rear of this Section. These instructions must be followed exactly, especially the grounding instructions.</p>	 <p><b>REFER TO MP85.5105</b></p>
<p>e. One or more jacks are lifting the coach out of level during the stabilize mode.</p>	<p>The jack pressure switches are not closing at the correct time. Try to adjust the pressure switch by loosening the locknut and turning the threaded plastic body counter clockwise 1/4 turn and then retry. Continue this until the desired stabilizing effect is reached. The jacks used to stabilize should lift the coach a minimum of 1/2 inch.</p> <p>If adjusting the pressure switch does not help, unplug the harness wire going to the jack and ground the pin in the harness plug. Retry the system. If the jack still extends during the stabilize mode, replace the control box. If the jack does not extend, replace the pressure switch. If it still does not work properly, refer to the FIELD ENHANCEMENT instructions at the rear of this Section.</p>	 <p><b>REFER TO MP85.5105</b></p>

# REPAIR STEPS

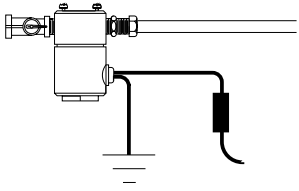
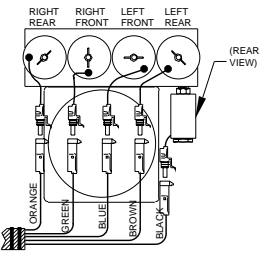
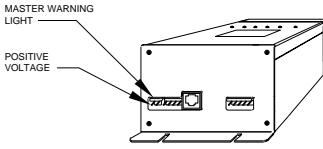
PROBLEM	SOLUTION	DIAGRAMS	
<p><b>Part 10</b> The coach will not return to ride height.</p>	<p><b>AUTOMATIC RETRACT</b></p> <p>The air dump solenoids are not closing. Recheck Part 6b of this Section. Some air solenoids are equipped with emergency shutoff valves.</p>	 <p><b>REFER TO MP75.5010</b></p>	
<p><b>Part 11</b></p> <p>a. The pump comes on after pushing the "I" button one time.</p>	<p>Solenoid B, the pump solenoid, is probably stuck. The system cannot retract if the pump is running. Recheck Part 3d of this Section.</p>	 <p><b>REFER TO MP85.5067</b></p>	
<p>b. A jack will not retract to the horizontal position.</p>	<p>Check the solenoid wires for +12 volts while the store indicator light is flashing. If +12 volts is not present, check the 10 amp fuse at the control box. If the fuses are not blown, replace the control box. If +12 volts is present on the solenoid wires, recheck Part 5b. of this Section.</p>		
<p>c. Red warning lights on the touch panel do not go out, but the jacks have retracted.</p>	<p>First, unplug the jack pressure switch for the proper jack. If the red warning light goes out, replace the jack pressure switch. If the light does not go out, unplug the warning switch wire. If the light goes out, replace the warning switch. If the light does not go out, check the wire for a short to ground. If the wire is ok, replace the control box.</p>		<p><b>REFER TO MP85.5110</b> <b>REFER TO MP85.5115</b> <b>REFER TO MP85.5120</b></p>
<p>d. The master "JACKS DOWN" warning light on the dash will not go out.</p>	<p>Unplug the 2 pin MTA connector and check the ground wire going to the master warning light. If it is not shorted to ground, replace the control box. This light should be on whenever a warning light on the touch panel is on.</p>		 <p><b>REFER TO MP85.5043</b></p>
<p>e. The green travel light will not come on.</p>	<p>The green travel light will not come on if any red warning lights are on. If no red warning lights are lit, replace the control box.</p>		

# FIELD ENHANCEMENT FOR 610 SYSTEMS

**STEP "1"** below should be performed on all 610 Systems as applicable.

## 1A. GROUND CONTROL BOX

All 610 Systems should have the control box grounded directly to the frame rail. See Instruction Sheet MI91.2248. If box is not grounded to frame use Box Grounding Kit RAP0999. (RAP0999 is included in the Motor Grounding Kit RAP0838 below.)

## 1B. GROUND 3" MOTOR

All Fenner Stone power units with 3" diameter motors should have a ground cable on the motor as shown on Instruction Sheet MI91.2270.

Stone power units with 3" diameter motors were first furnished in mid year 1992. The ground cable was added in mid year 1993.

The 3" motors were used on some manually controlled leveling systems and on all computerized systems except those with the 3.5 gallon square reservoirs. Use Grounding Kit RAP0838.

Obtain the coach VIN number, the owner's name and address and send them to HWH Corporation, "ATTENTION: WARRANTY DEPARTMENT", noting that the Pump Motor Ground was added

**STEP "2"** below should be performed if the system is not properly sensing the switches on the jacks.

## 2A. KICK-DOWN JACKS-PRESSURE SWITCH, WARNING SWITCH AND GROUNDING

Replace the pressure switch if existing pressure switch does not have a rubber boot on top. Use RAP8003 Pressure Switch. New style RAP8003 does NOT have a rubber boot.

Replace the warning switch and ground new switch directly to chassis frame rail. Use RAP0995 Warning Switch. See Instruction Sheet MI91.2272 for 6000# jacks. See Instruction Sheet MI91.2274 for 9000# jacks.

## 2B. STRAIGHT-ACTING JACKS PRESSURE SWITCH, WARNING SWITCH AND GROUNDING

Replace pressure switch if the existing pressure switch does not have a rubber boot on top. Use RAP8003 Pressure Switch.

Replace the warning switch and ground the new switch directly to the chassis frame rail. Use RAP1009 Warning Switch. New style RAP8003 does NOT have a rubber boot.

The pressure switches will have to be grounded with a RAP0770 Ground Kit if the warning switches are the one wire style.

## 2C. PRESSURE SWITCH ADJUSTMENT

New pressure switches may need to be adjusted so that when stabilizing, the jacks will touch the ground and lift the coach 1/2" to 1". See MI95.44 in this manual.

**STEP "3"** - Replace the control box and the touch panel at this time if system operation is not operating correctly. The control box is 3" x 4" x 7" aluminum, generally located under the dash.

**STEP "4"** - Applies only to 6000# or 9000# kick-down jacks. In certain cases, replacing actuators improve the leveling or stabilizing function. Consult HWH Corporation before performing this step.

On a 6000# jack, replace the actuator by using an RAP0448 Actuator Kit. On a 9000# jack, replace the actuator by using an RAP0547 Actuator Kit and an RAP1029 Tube and Fitting Kit. See Instruction Sheet MI91.2276.

# GROUNDING INSTRUCTIONS 610 CONTROL BOX

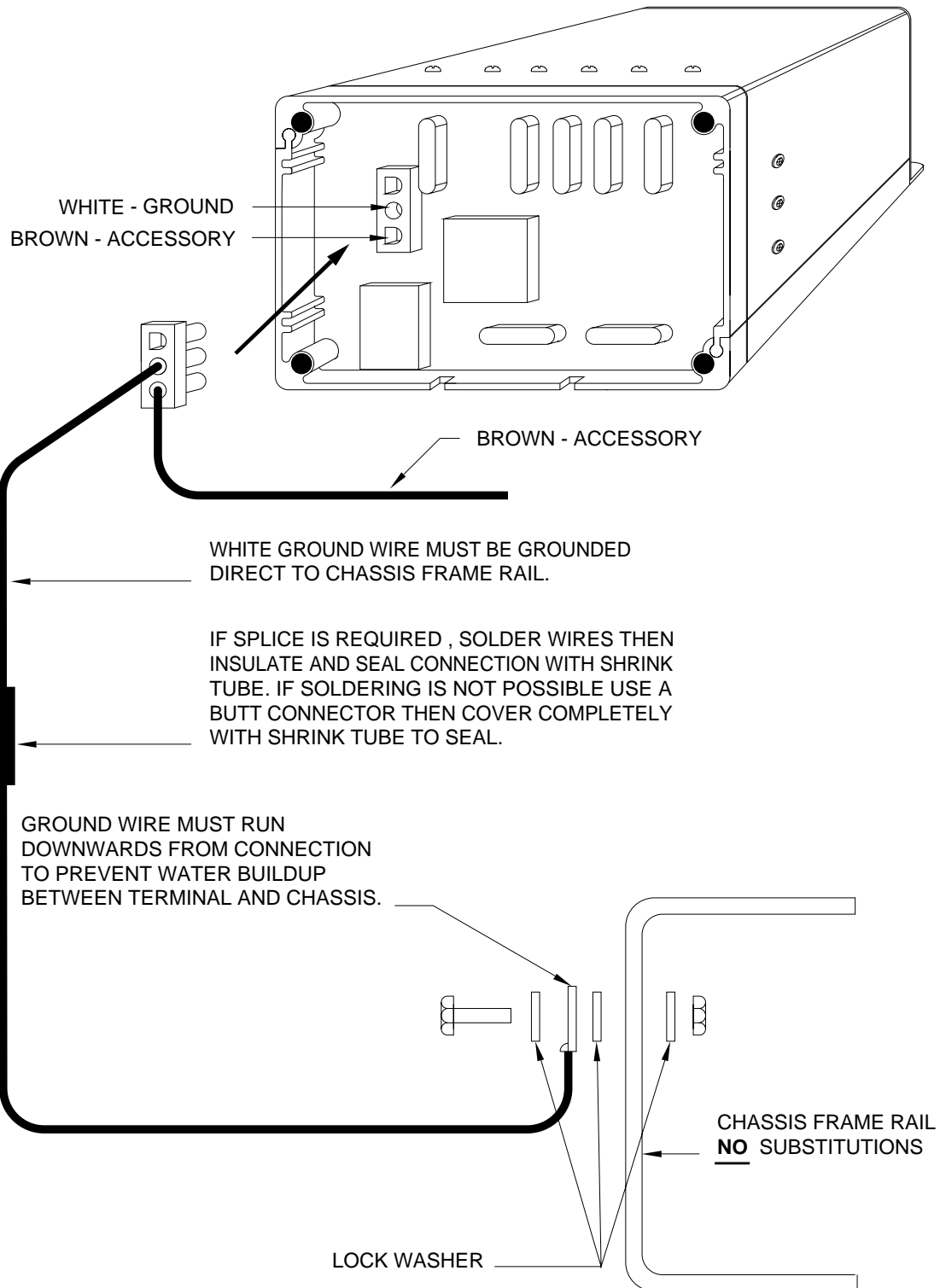

## GROUNDING INSTRUCTIONS

- 1) GRIND FRAME RAIL CLEAN.
- 2) DRILL 1/4" DIAMETER HOLE.
- 3) IMPORTANT: PLACE INTERNAL LOCK WASHERS ON BOTH SIDES OF TERMINAL AND UNDER NUT.
- 4) SEAL BOTH SIDES WITH SILICONE CAULKING.

RAP0999 BOX GROUND KIT

MI91.2248  
25JUN98



# GROUND CABLE INSTALLATION FOR FENNER STONE PUMPS

SEE OPERATOR'S MANUAL FOR CONNECTION INFORMATION OF GROUND WIRES AND SOLENOIDS.

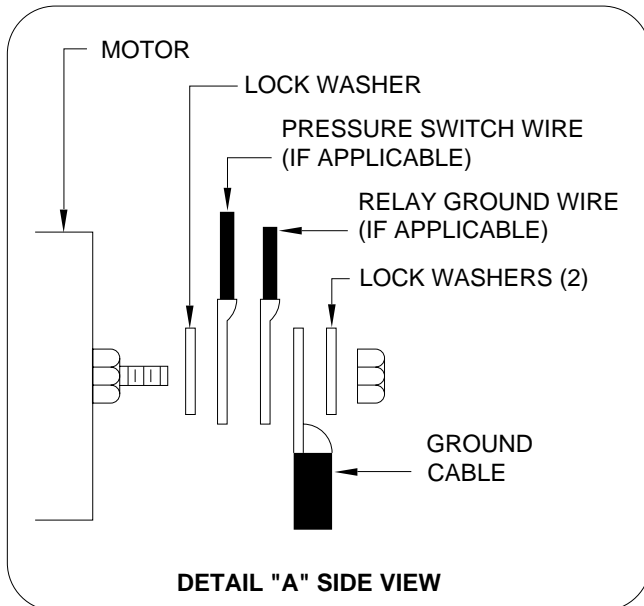
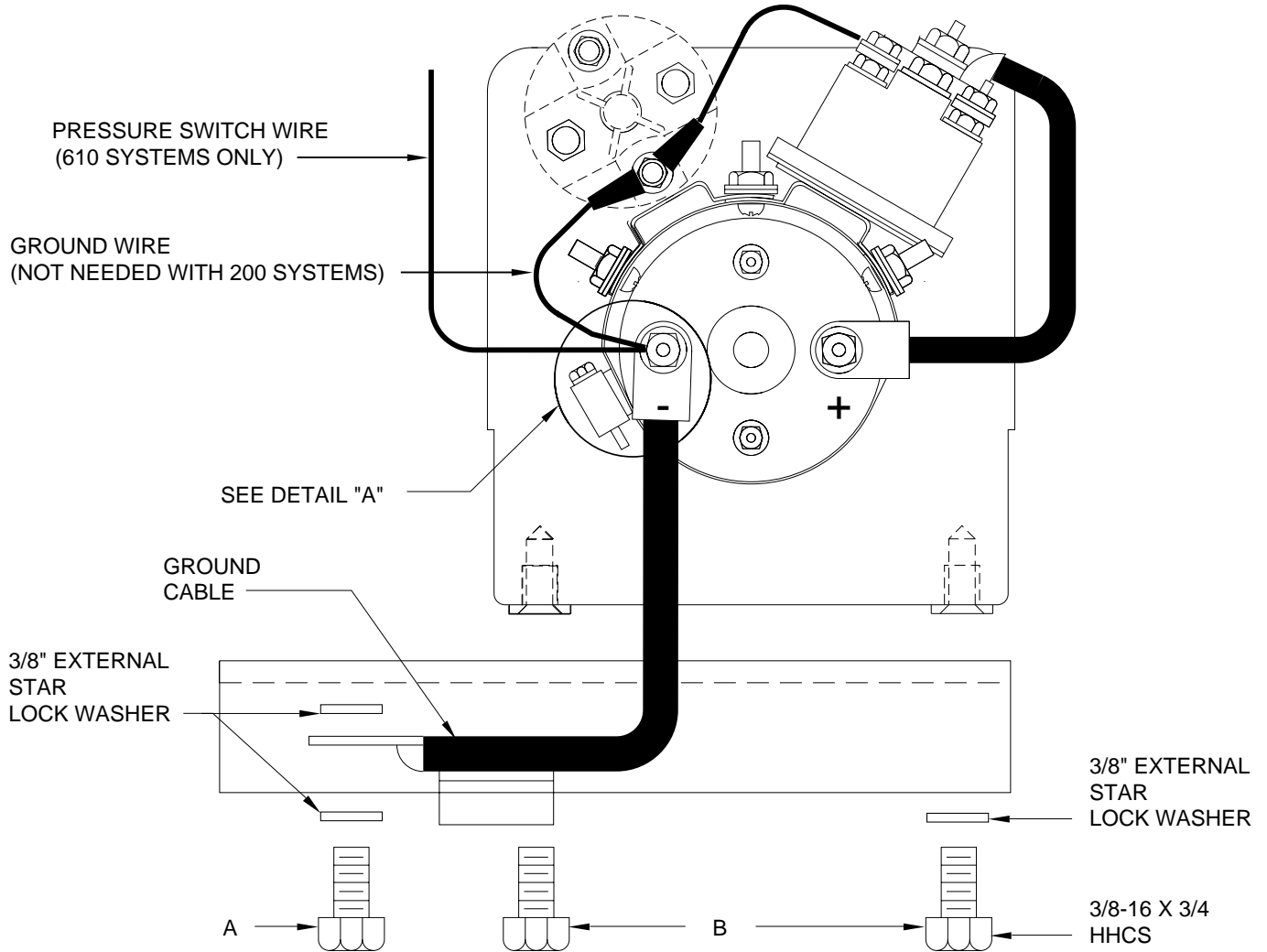

CONNECT GROUND CABLE STRAP FROM NEGATIVE ("-") MOTOR TERMINAL TO PUMP CHANNEL MOUNTING BOLT (A). IF PUMP CHANNEL IS WELDED TO FRAME, CONNECT GROUND CABLE STRAP TO A PUMP MOUNTING BOLT (B). A 3/8" EXTERNAL STAR LOCK WASHER MUST BE USED BETWEEN GROUND CABLE STRAP TERMINAL/PUMP CHANNEL AND BETWEEN GROUND CABLE STRAP TERMINAL/BOLT HEAD OR NUT.

RAP0838 GROUND STRAP KIT

# GROUNDING INSTRUCTIONS

## 6,000# KICK-DOWN JACKS

### GROUNDING INSTRUCTIONS

- 1) GRIND FRAME RAIL CLEAN.
- 2) DRILL 1/4" DIAMETER HOLE.
- 3) IMPORTANT : PLACE EXTERNAL LOCK WASHERS ON BOTH SIDES OF TERMINAL AND UNDER NUT.
- 4) SEAL BOTH SIDES WITH SILICONE CAULKING.

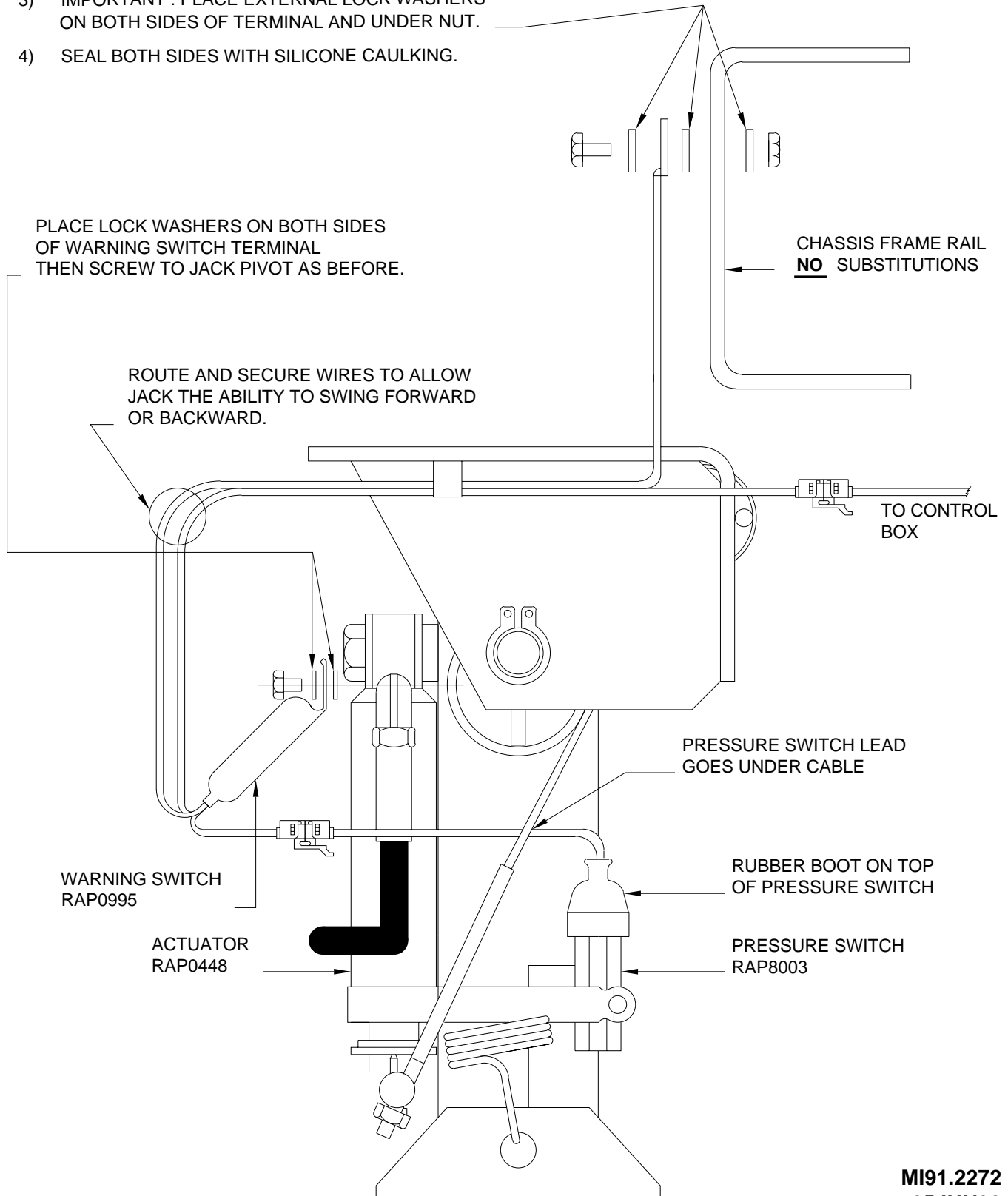

# GROUNDING INSTRUCTIONS

## 9,000# KICK-DOWN JACKS

### GROUNDING INSTRUCTIONS

- 1) GRIND FRAME RAIL CLEAN.
- 2) DRILL 1/4" DIAMETER HOLE.
- 3) IMPORTANT : PLACE EXTERNAL LOCK WASHERS ON BOTH SIDES OF TERMINAL AND UNDER NUT.
- 4) SEAL BOTH SIDES WITH SILICONE CAULKING.

ROUTE AND SECURE WIRES TO ALLOW JACK THE ABILITY TO SWING FORWARD OR BACKWARD.

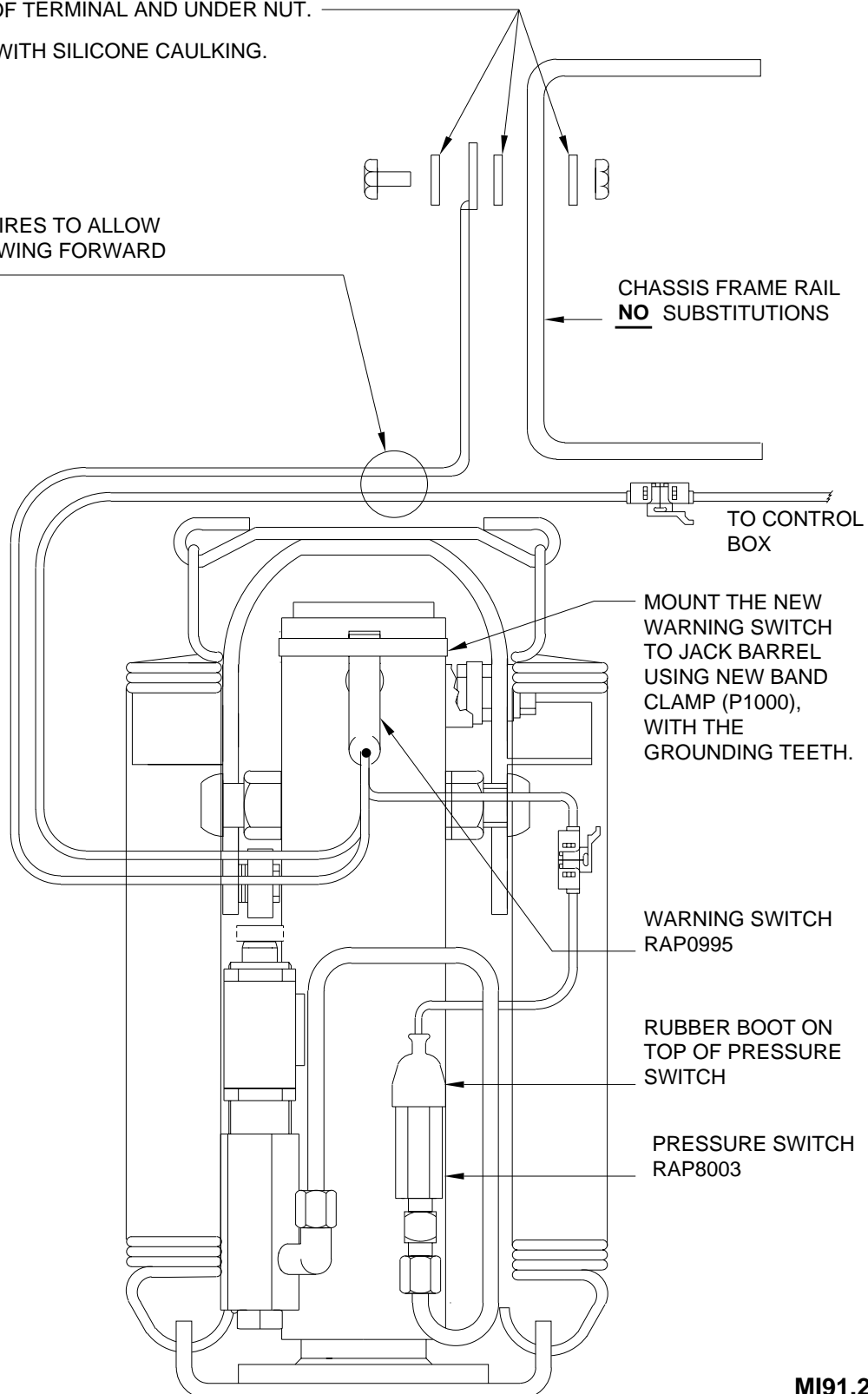

9,000# JACK  
VIEWED FROM REAR

MI91.2274  
25JUN98

**MOUNTING INSTRUCTIONS  
PRESSURE SWITCH ON BACK SIDE  
9,000# KICK-DOWN JACKS**

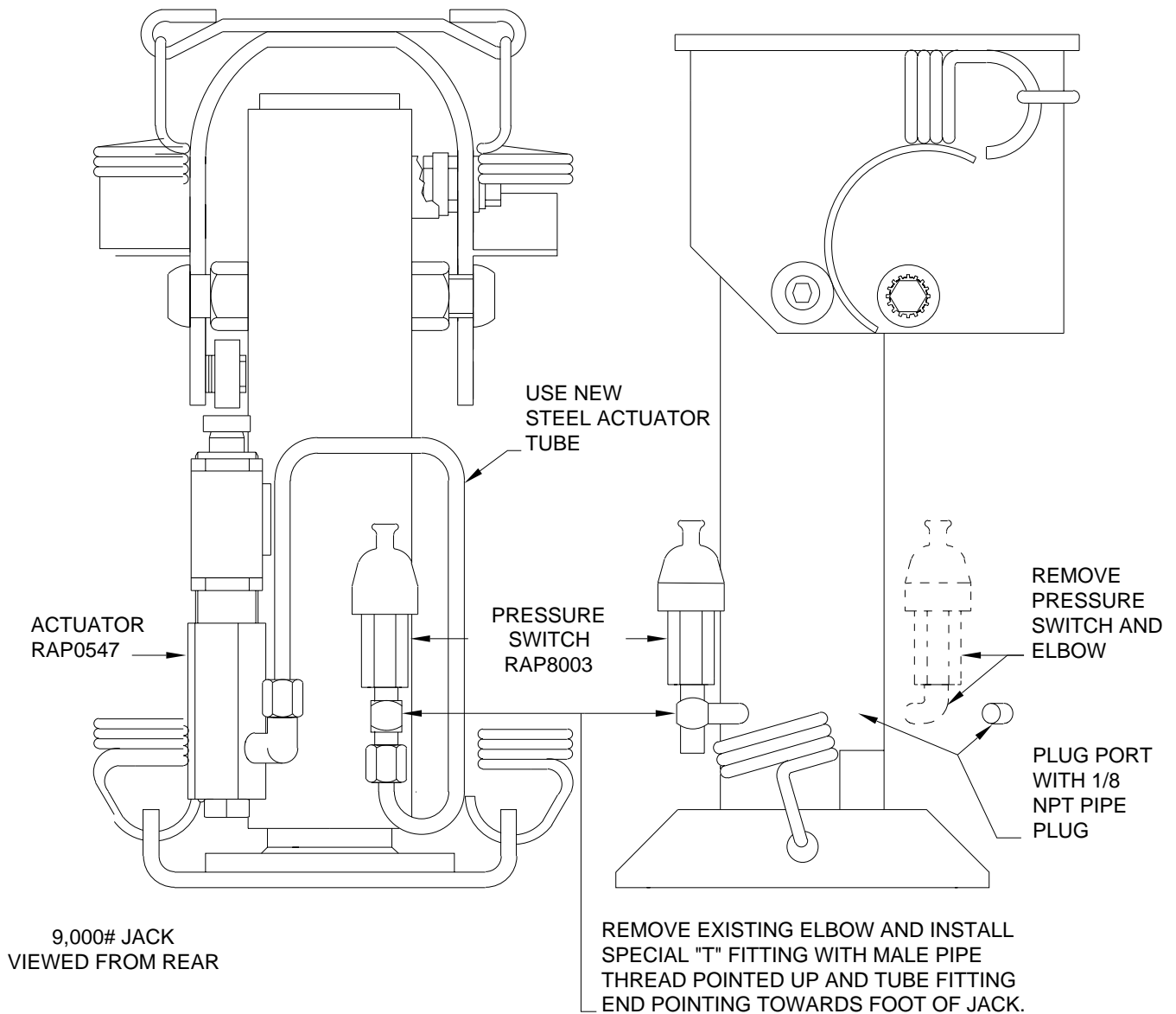

**NOTE:** ACTUATOR STEEL TUBE AND SPECIAL "T"  
FITTING ARE AVAILABLE AS A KIT (RAP1029).

---

## 6000# JACK HOSE AND WIRING INSTRUCTIONS

---

1. Install brackets and jacks using correct installation procedures. (See Installation Manual)

This jack is usually supplied with the wiring and a short hose already installed on the jack. For clearance purposes the hose and wire may be clamped to the opposite side of the jack. Check carefully that the hose and wire will not catch on the jack and that the jack may fold, swing vertical and swing to the front without damage to the hose or wire.

2. Ring terminal on warning switch must be grounded directly to the frame rail.
  - A. Grind the frame rail clean where ring terminal will be grounded.
  - B. Drill 1/4" hole in frame.
  - C. **IMPORTANT:** Place internal lock washers on both sides of the terminal and under the nut.
  - D. Seal both sides of bolt with silicone caulking.
3. Plug packard connector into correct wire from control box. (See Installation or Operator's Manual)

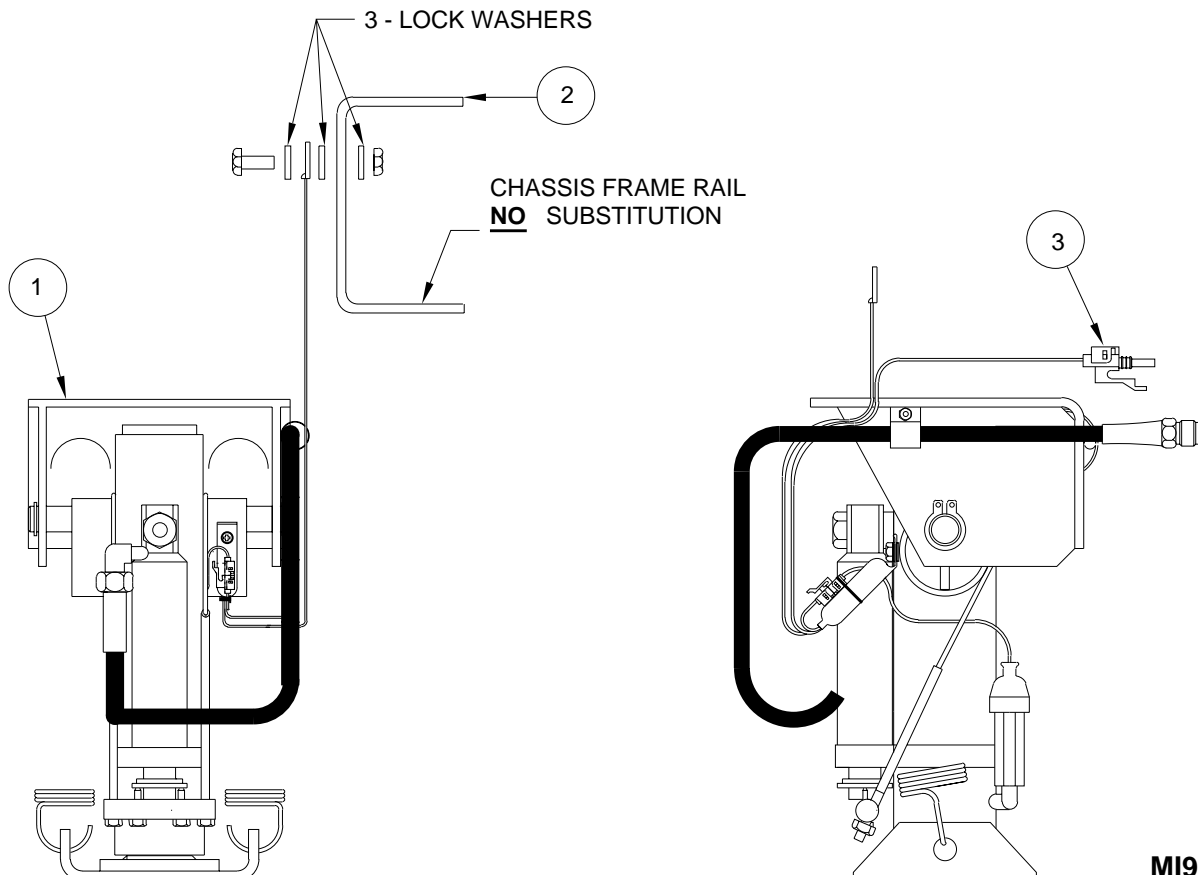

## 9000# JACK HOSE AND WIRING INSTRUCTIONS

1. Install brackets and jacks using correct installation procedures. (See Installation Manual)
2. Route hose above roller bearing, in front of pivot nut and connect to the actuator fitting.
3. Clamp hose to pivot bracket using hose clamp. Locate clamp on hose so that there is no slack in hose when jack is folded.
4. Route warning switch wires around front of jack and wire tie to hose by hose clamp. Check that jack can fold without damaging or stretching wires.
5. Ring terminal on warning switch must be grounded directly to the frame rail.
  - A. Grind frame rail clean where ring terminal will be grounded.
  - B. Drill 1/4" hole in frame.
  - C. **IMPORTANT:** Place internal lock washers on both sides of terminal and under nut.
  - D. Seal both sides of bolt with silicone caulking.
6. Plug packard connector into correct wire from control box. (See Installation or Operator's Manual)

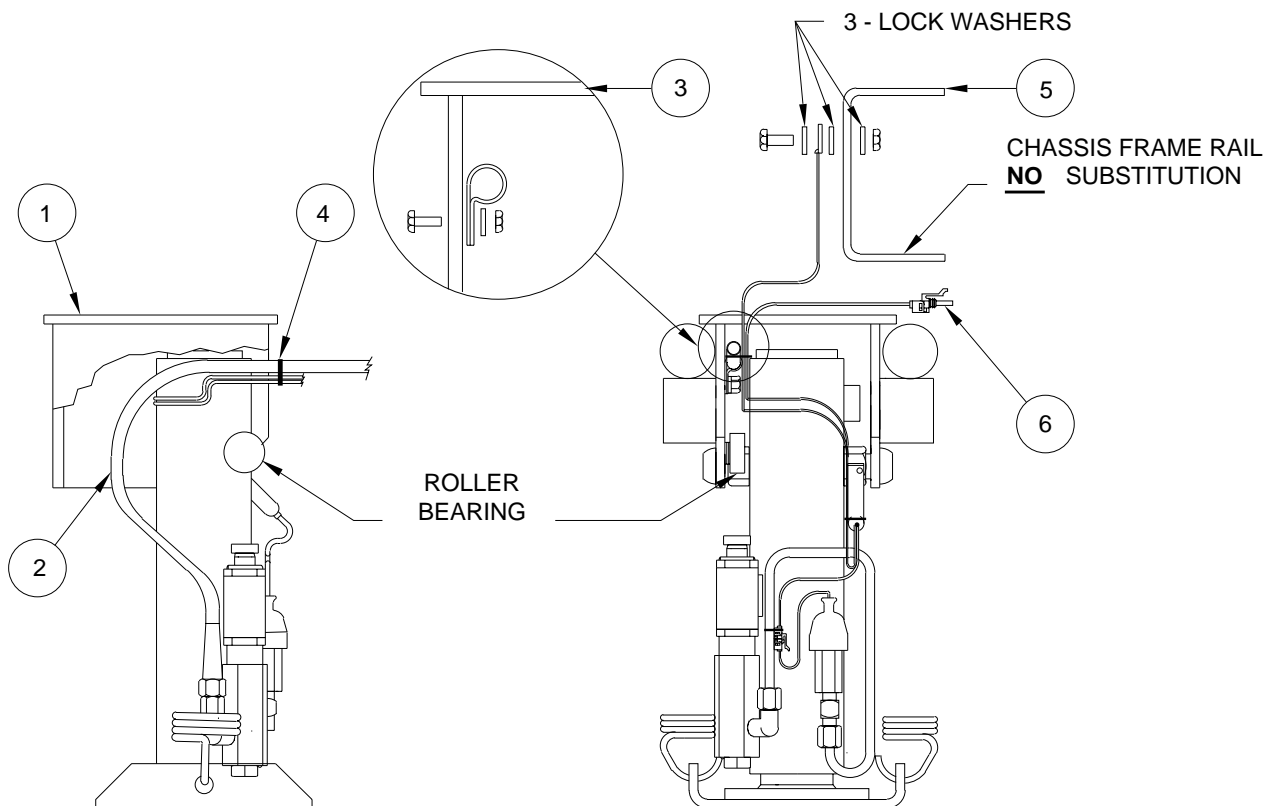

# 16,000# JACK HOSE AND WIRING INSTRUCTIONS

1. Install brackets and jacks using correct installation procedures. (See Installation Manual)
2. Route hose around left pivot, between cylinder and wires, then across back side of cylinder and connect to actuator fitting.
3. Clamp hose to pivot bracket using hose clamp. Locate clamp on hose so that there is no slack in hose when jack is folded.
4. Wire tie wires to hose 1.0" from jack. Check that the jack will fold, swing vertical and swing to the front without damage to the hose or wire.
5. Ring terminal on warning switch must be grounded directly to frame rail.
  - A. Grind frame rail clean where ring terminal will be grounded.
  - B. Drill 1/4" hole in frame.
  - C. **IMPORTANT:** Place internal lock washers on both sides of terminal and under nut.
  - D. Seal both sides of bolt with silicone caulking.
6. Plug packard connector into correct wire from control box. (See Installation or Operator's Manual)

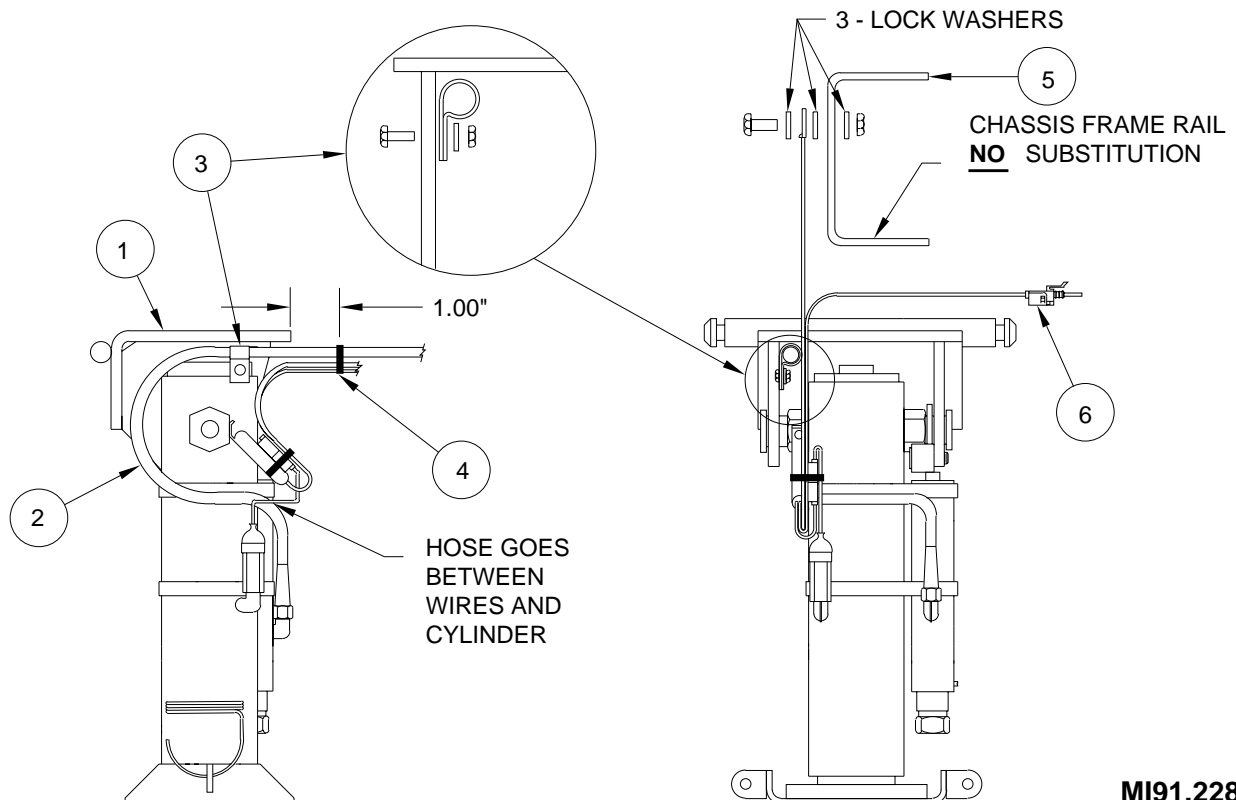



## PRODUCT/SERVICE BULLETIN

**ISSUE DATE:** July 26, 2010

**TO:** All O.E.M. Manufacturers and Installers

**FROM:** HWH Corporation

**RE:** Adjustment for all jack pressure switches

### ADJUSTMENT FOR ALL JACK PRESSURE SWITCHES

The 610, 625 and 725 systems utilize a pressure switch on each jack to achieve the proper stabilizing pressure. Each jack should lift the coach 1/4" to 3/4" when stabilizing the coach. This will vary due to type of suspension and chassis. There must be some lift to combat thermal contraction of the fluid. The coach should be leveled in several different positions so that each jack can be checked. These pressure switches are adjustable.

There is an old style pressure switch and a new style pressure switch. The old style pressure switch has a rubber boot covering the adjustment body and the jam nut. The new switch does not have a rubber boot, it has a sealing washer between the jam nut and the switch.

The adjustment for the two switches is the same except the rubber boot must be removed to access the adjustment body. When removing a rubber boot, be careful to not pull too hard on the switch wire. The wire connection to the switch could be damaged.

Before adjusting a switch, unplug the wire to prevent the wire from twisting. Remove the rubber boot if so equipped. Loosen the jam nut and use pliers to turn the adjustment body. If a jack needs to lift a little more for stabilizing, turn the adjustment body clockwise. This will increase the pressure. If a jack is lifting too high, turn the adjustment body counterclockwise. This will decrease the pressure. Only turn the adjustment body a half a turn at a time then check the operation of the system. Remember to plug the switch in for the test. Repeat as necessary. When the adjustments are complete, snug the jam nut back down. **DO NOT OVER TIGHTEN.** Hold the adjustment body with pliers to prevent the adjustment body from turning while tightening the jam nut. Replace the rubber boot if so equipped.

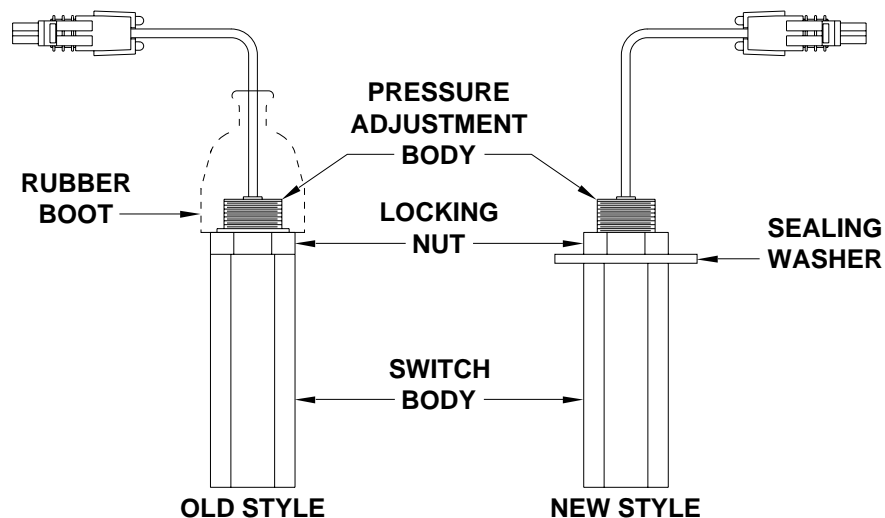

If the jacks or an individual jack comes down but does not touch the ground, do not adjust the level sensor. Adjust the pressure switch(es) as described above.

Please contact HWH Corporation at (800) 321-3494 for technical advice or assistance.



# HYDRAULIC LINE CONNECTION DIAGRAM LEVELING SYSTEM



FRONT

**NOTE:** BEFORE OPERATING VALVE RELEASE "T" HANDLES, READ AND UNDERSTAND PROCEDURE FOR MANUAL JACK RETRACTION IN OPERATOR'S INSTRUCTIONS.

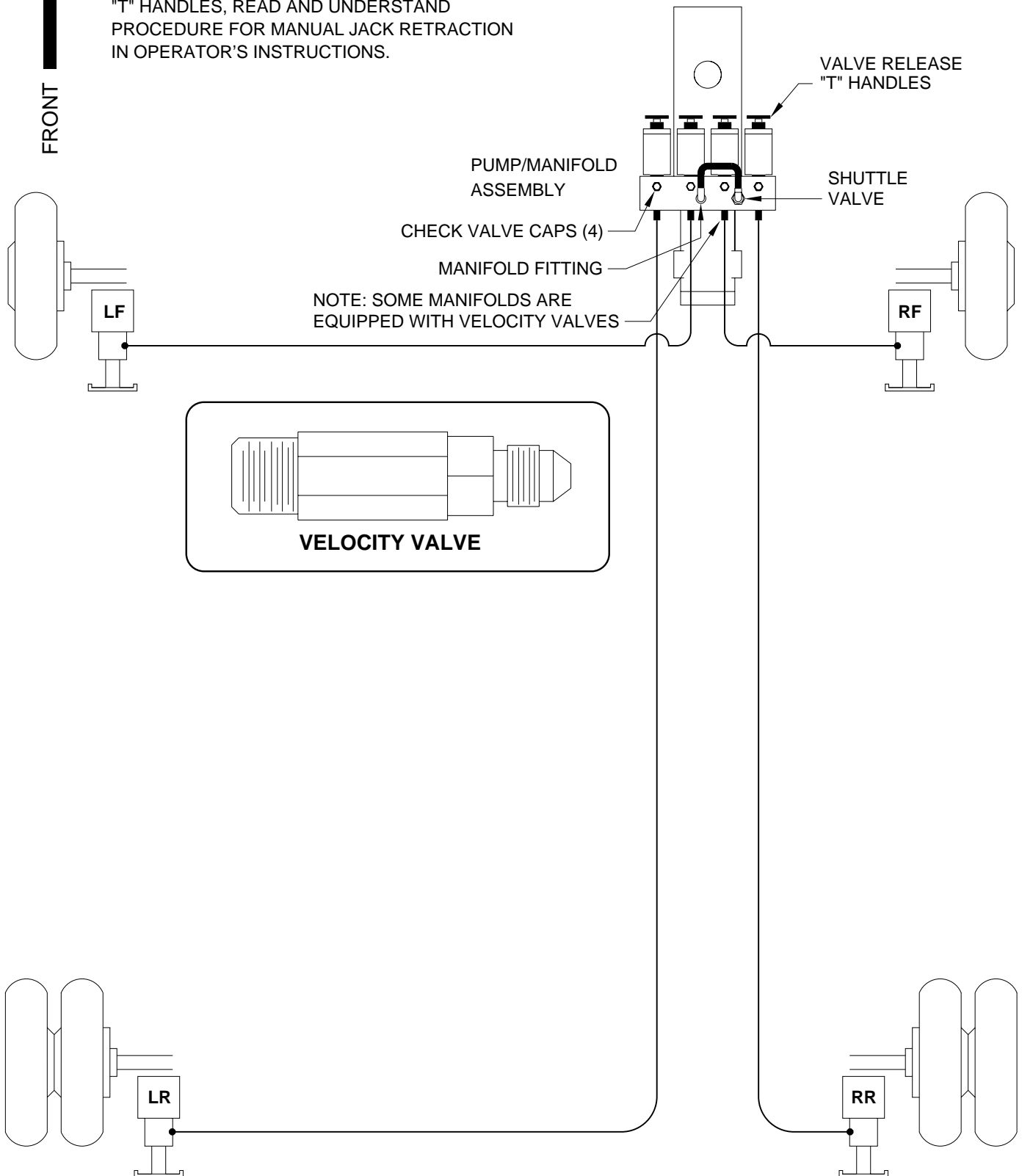

# HYDRAULIC SCHEMATIC BI-AXIS LEVELING WITH KICK-DOWN JACKS

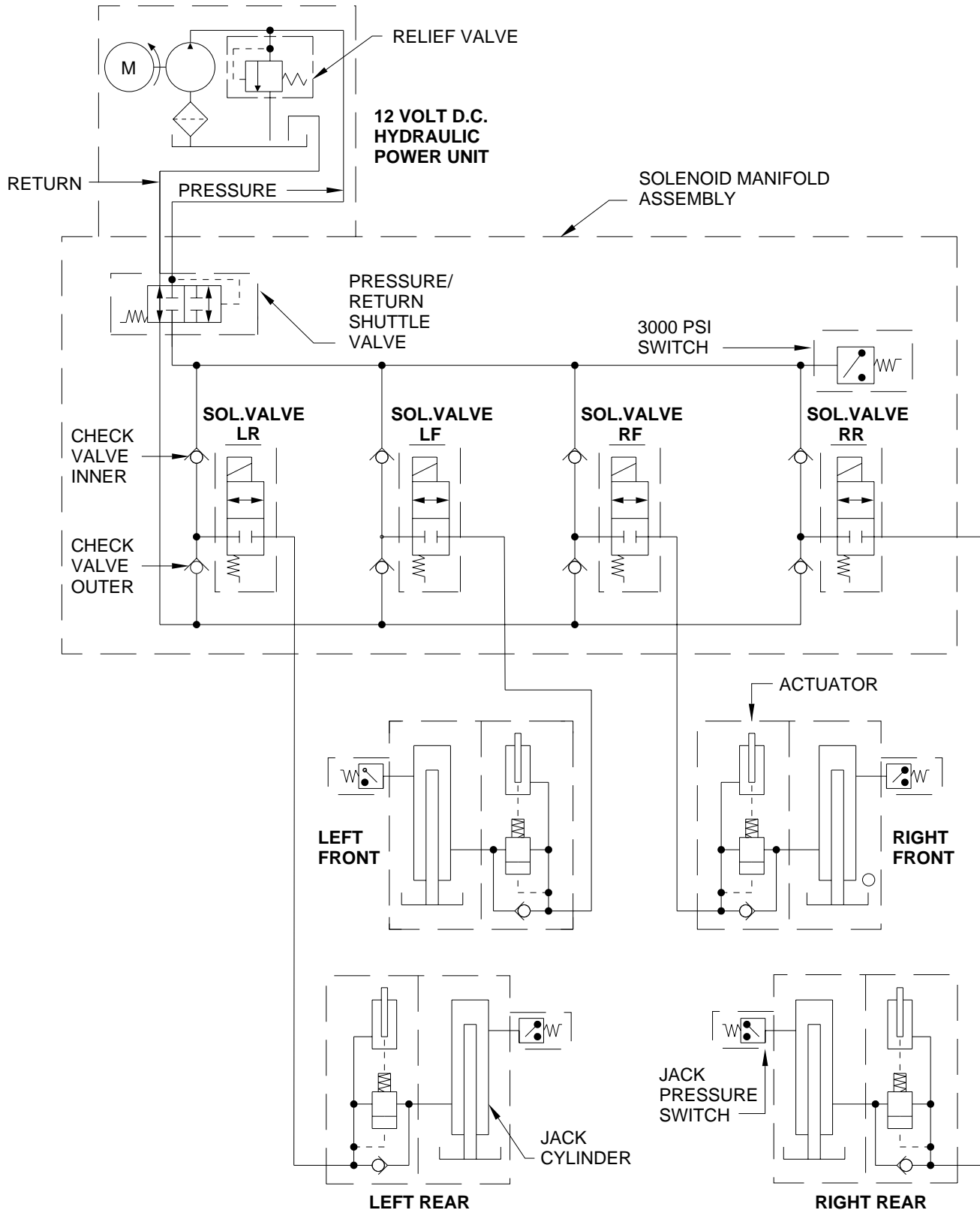

# SUSPENSION AIR DUMP SYSTEM LINE AND ELECTRICAL CONNECTION DIAGRAM

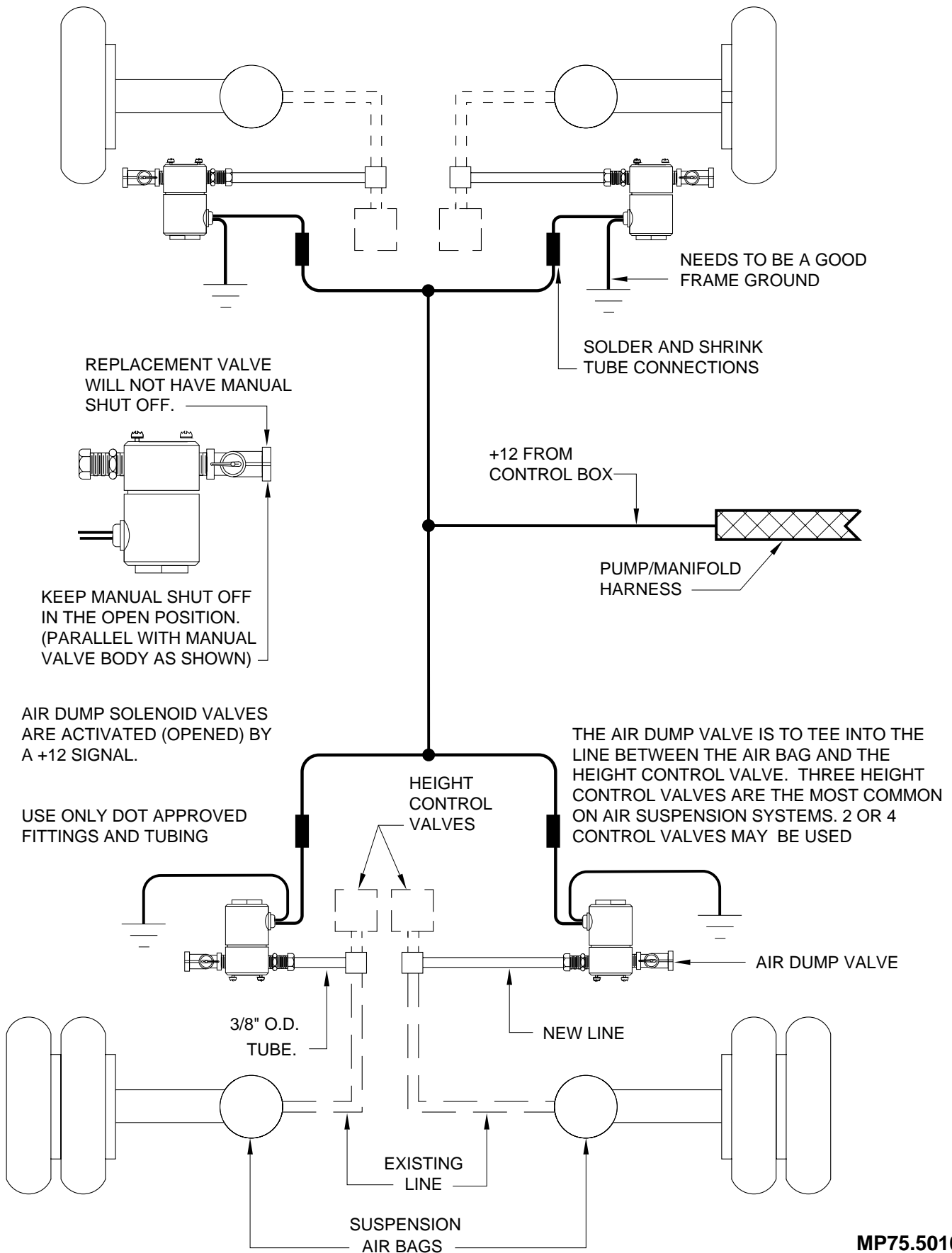

# CONNECTION INFORMATION

## 610 SERIES LEVELING SYSTEM CONTROL BOX

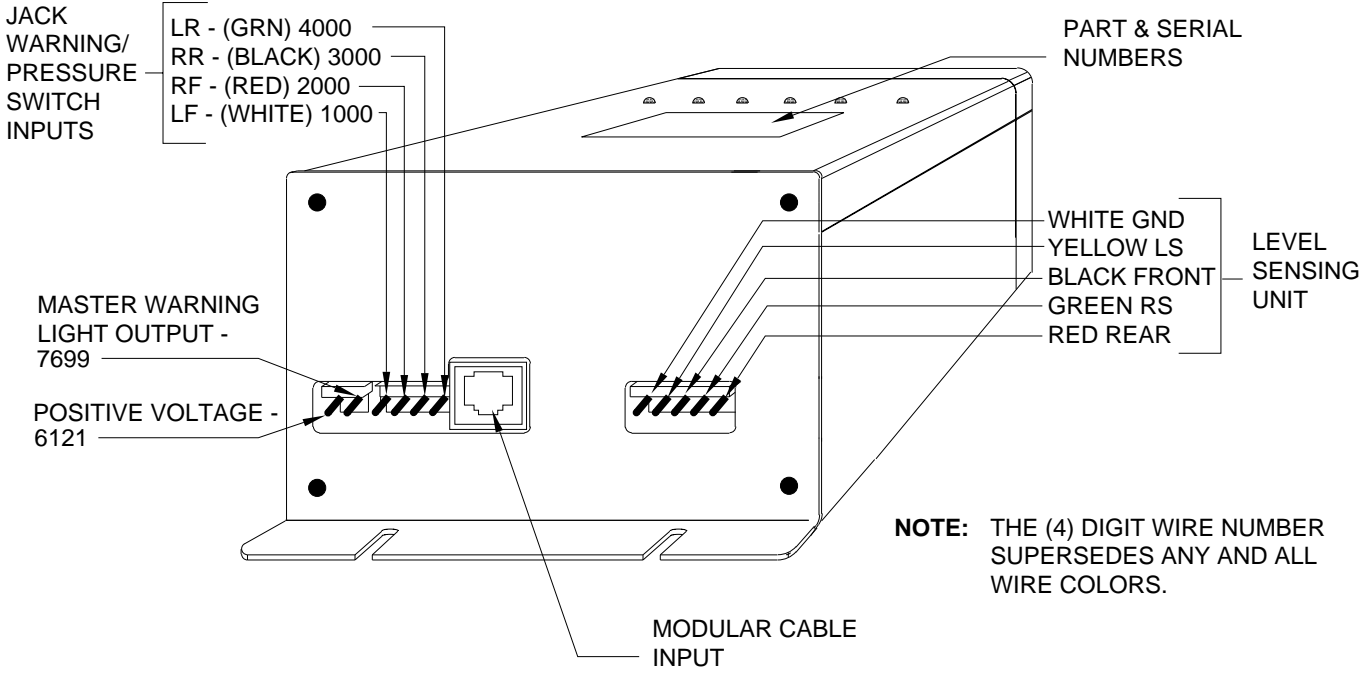
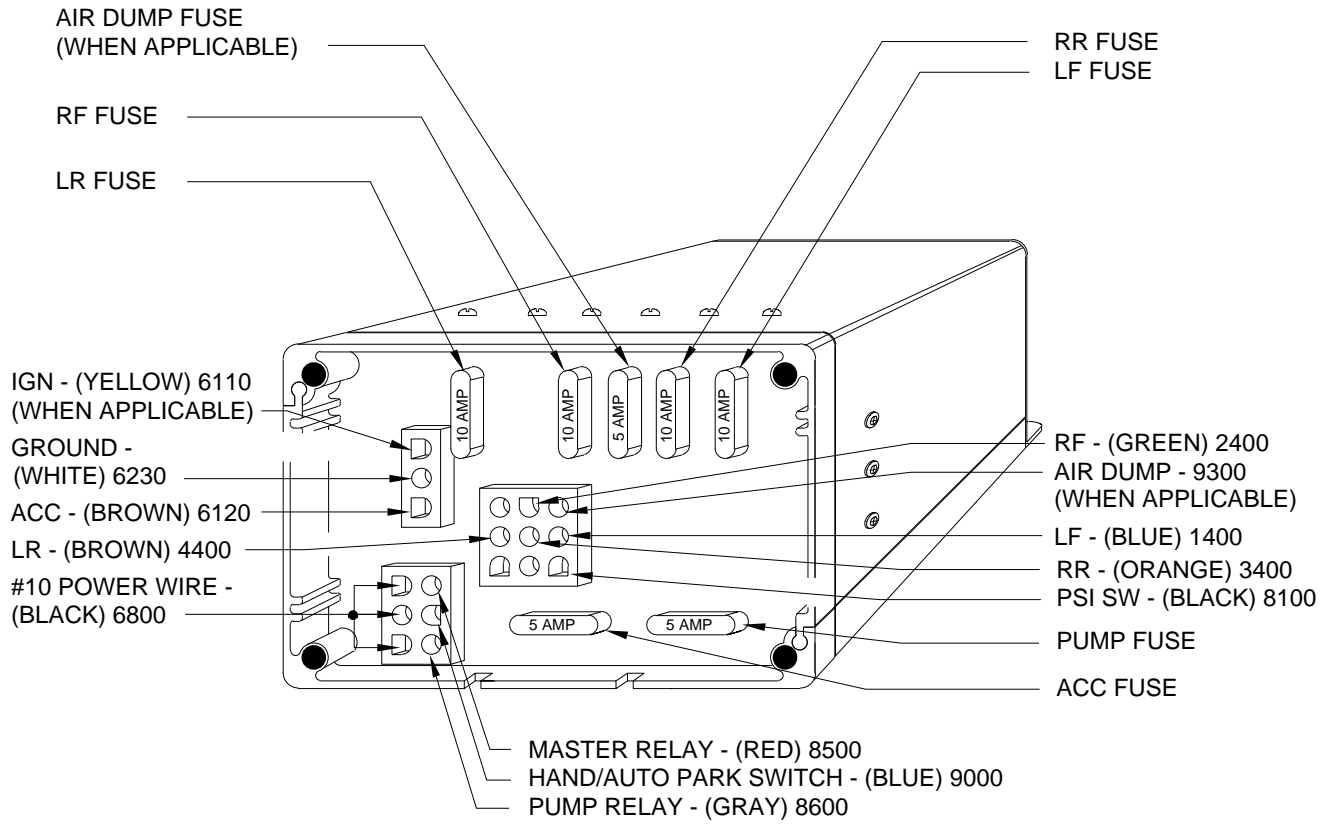

# ELECTRICAL CONNECTION DIAGRAM 610 LEVELING SYSTEMS

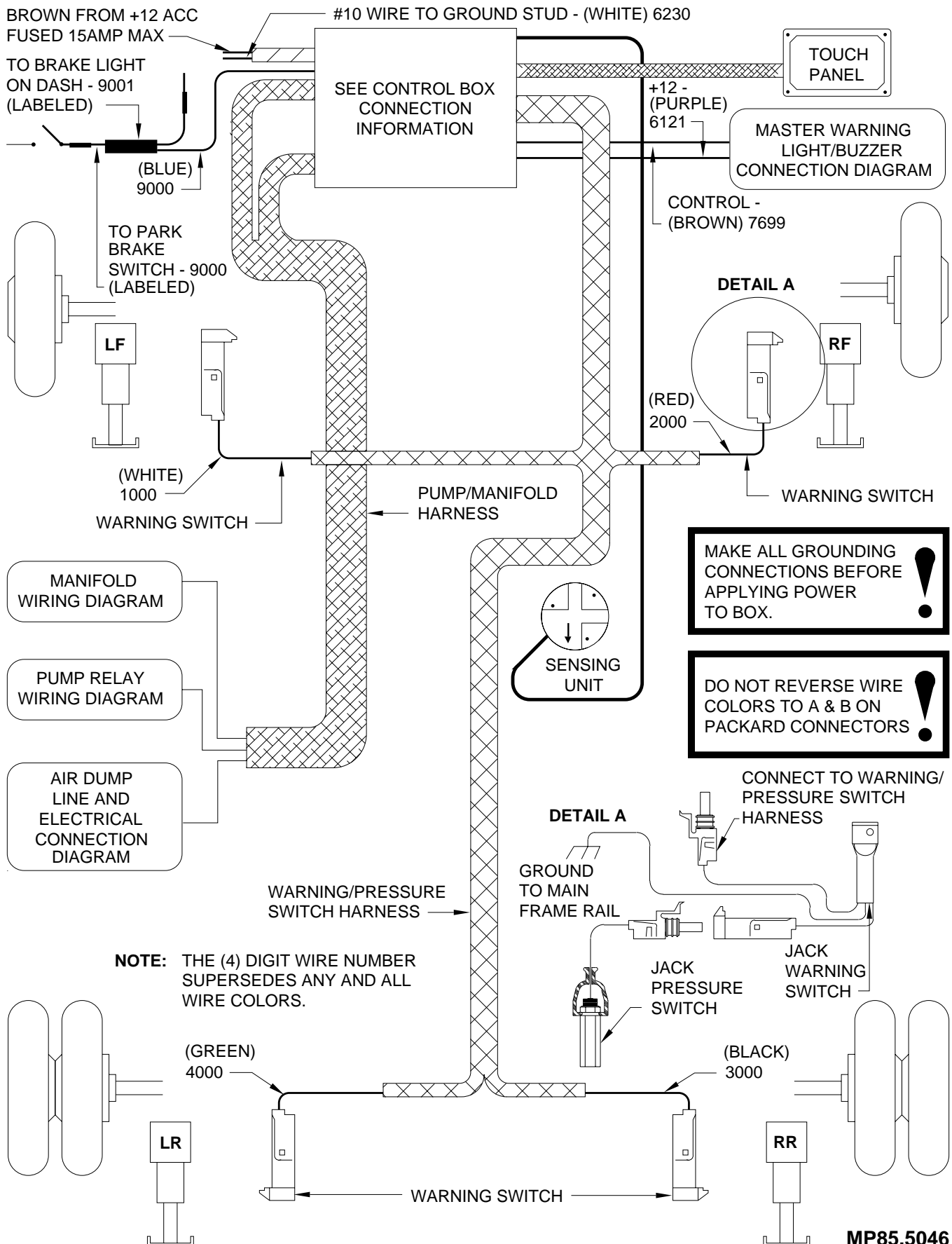

# MASTER AND PUMP RELAY WIRING DIAGRAM FOR 610 SERIES LEVELING SYSTEMS

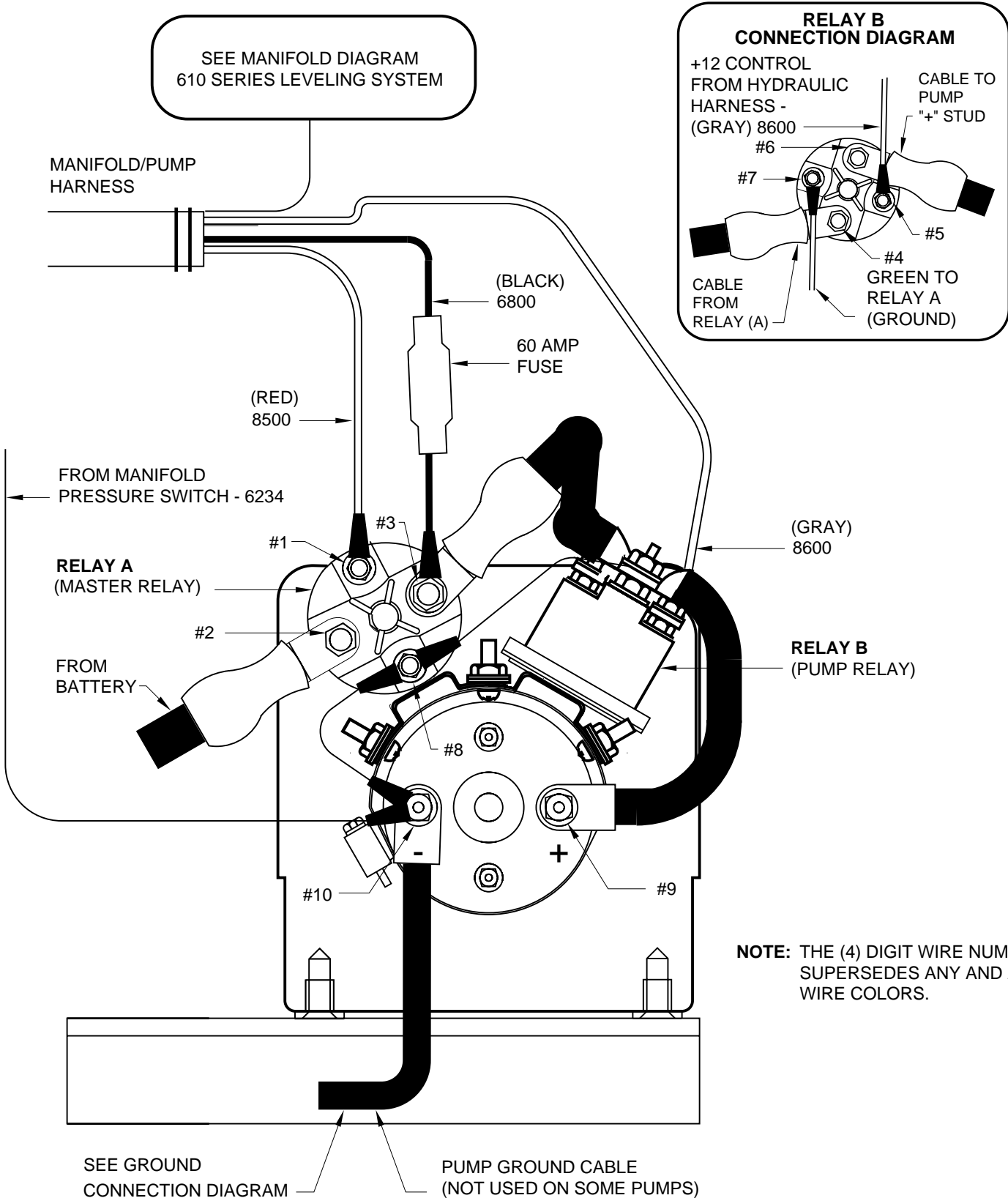

# MANIFOLD WIRING DIAGRAM 610 SERIES LEVELING SYSTEM

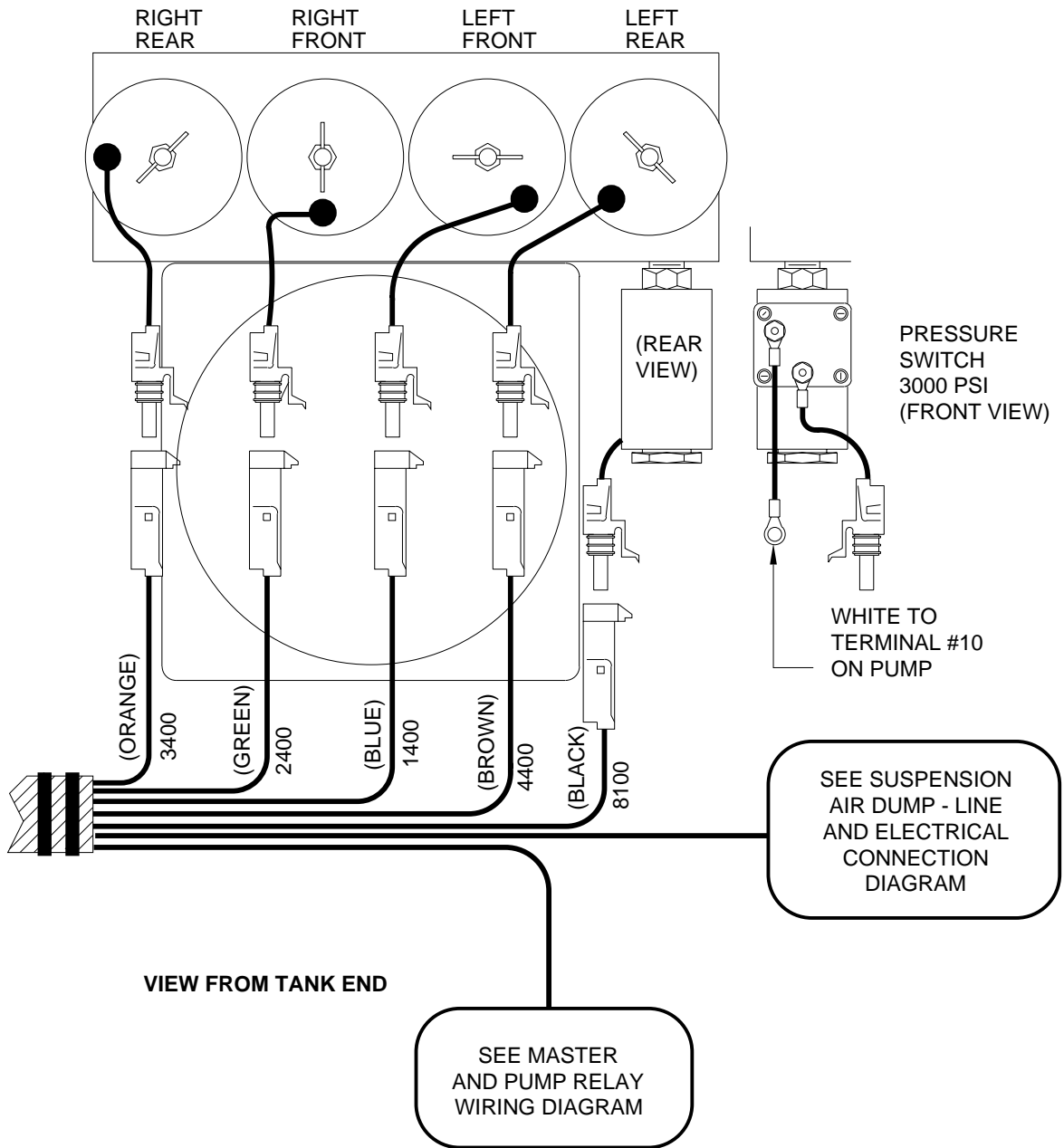

**NOTE:** THE (4) DIGIT WIRE NUMBER SUPERSEDES ANY AND ALL WIRE COLORS.

# GROUND CONNECTION DIAGRAM FOR FENNER STONE PUMPS

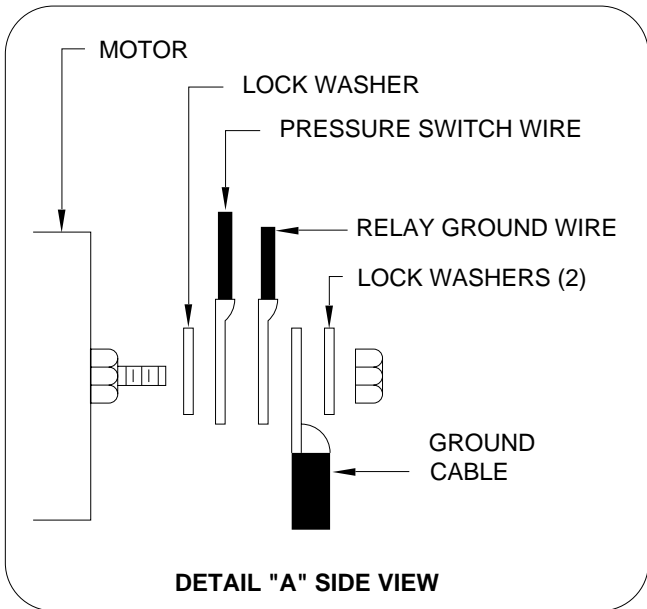
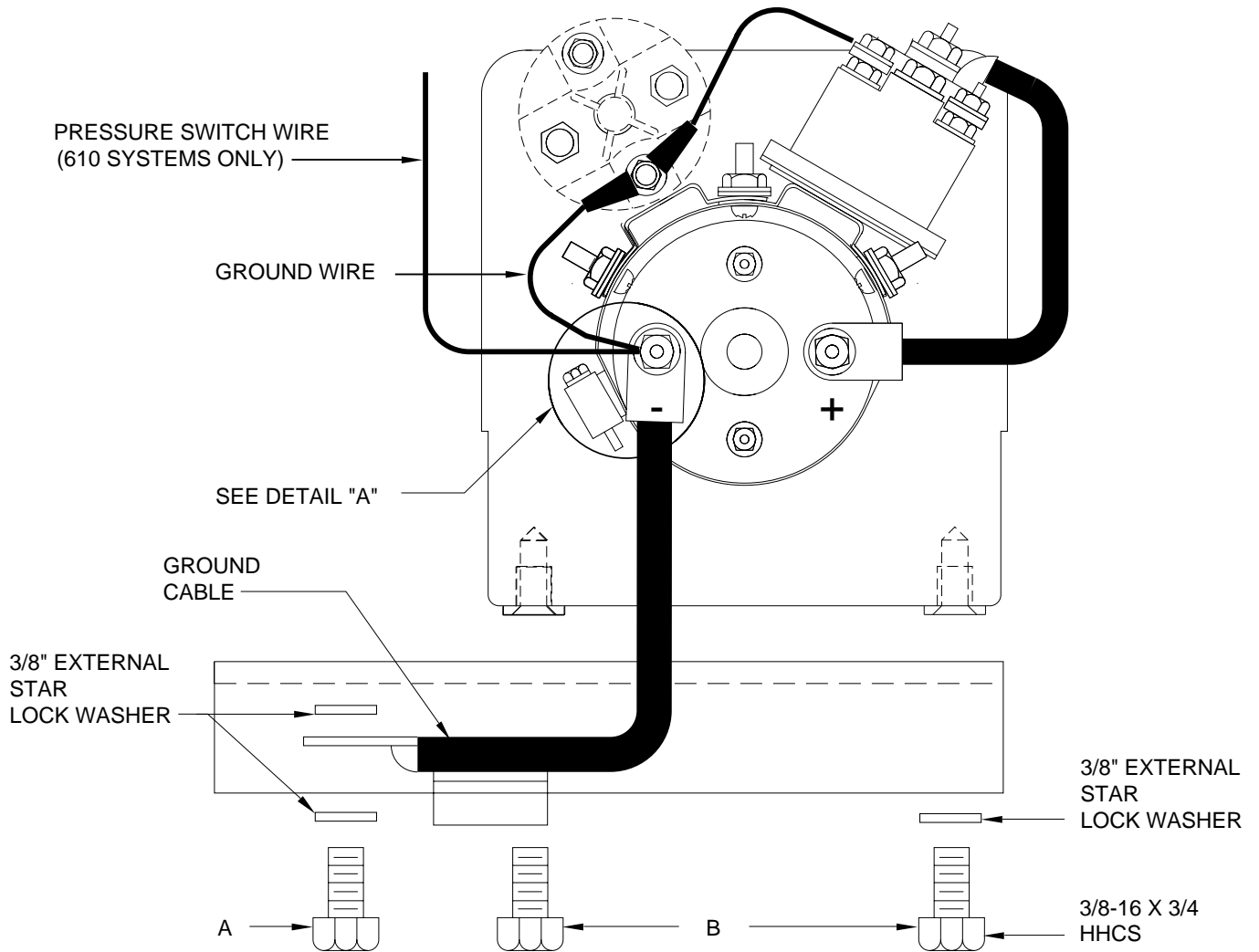

CONNECT GROUND CABLE STRAP FROM NEGATIVE ("-") MOTOR TERMINAL TO PUMP CHANNEL MOUNTING BOLT (A). IF PUMP CHANNEL IS WELDED TO FRAME, CONNECT GROUND CABLE STRAP TO A PUMP MOUNTING BOLT (B). A 3/8" EXTERNAL STAR LOCK WASHER MUST BE USED BETWEEN GROUND CABLE STRAP TERMINAL/PUMP CHANNEL AND BETWEEN GROUND CABLE STRAP TERMINAL/BOLT HEAD OR NUT.



---

**PRESSURE SWITCH  
ADJUSTMENT COMPONENT IDENTIFICATION**

---

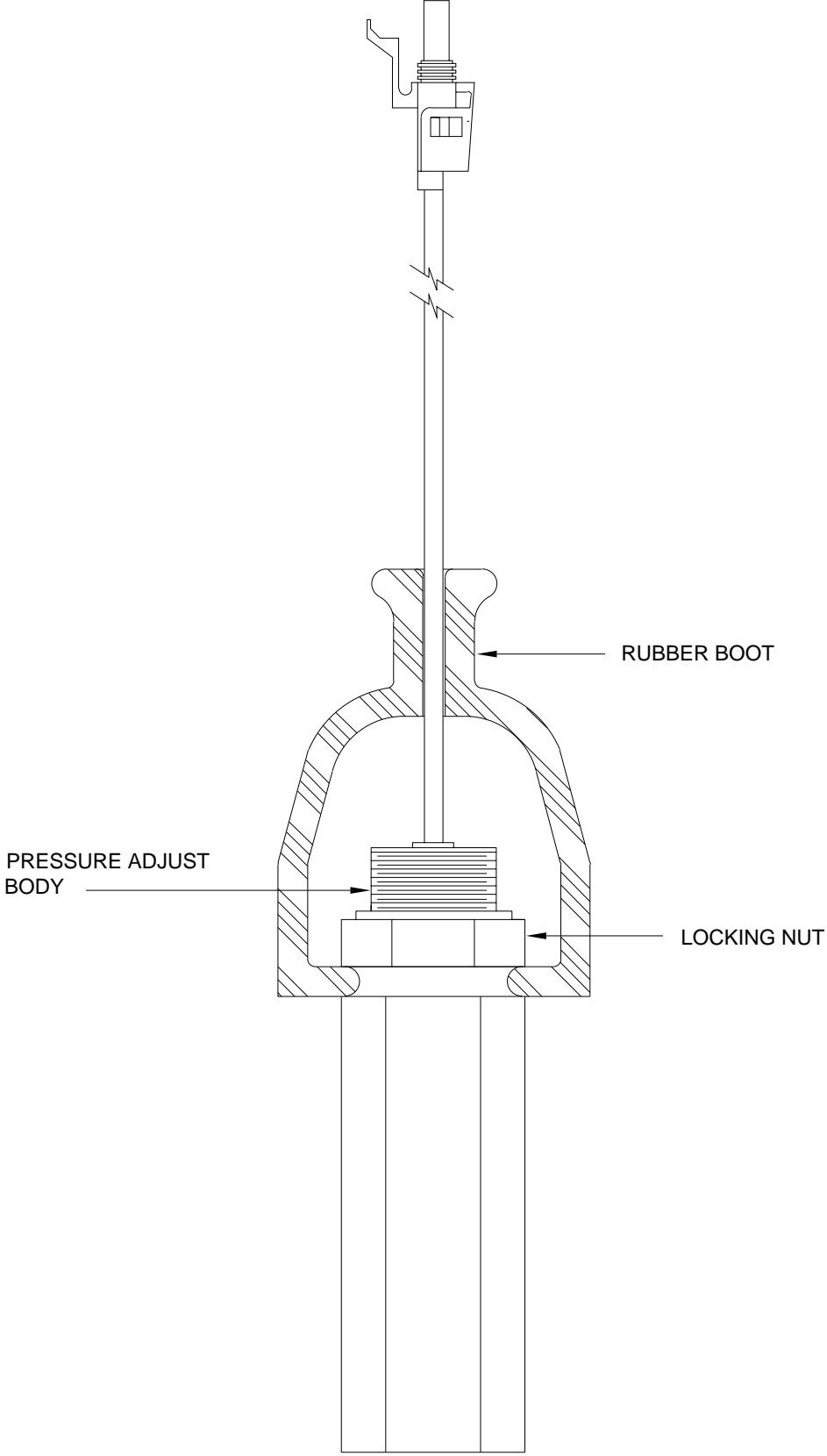

---

**6,000# CAPACITY JACK  
WITH PRESSURE SWITCH  
FOR 610 SERIES LEVELING SYSTEMS**

---

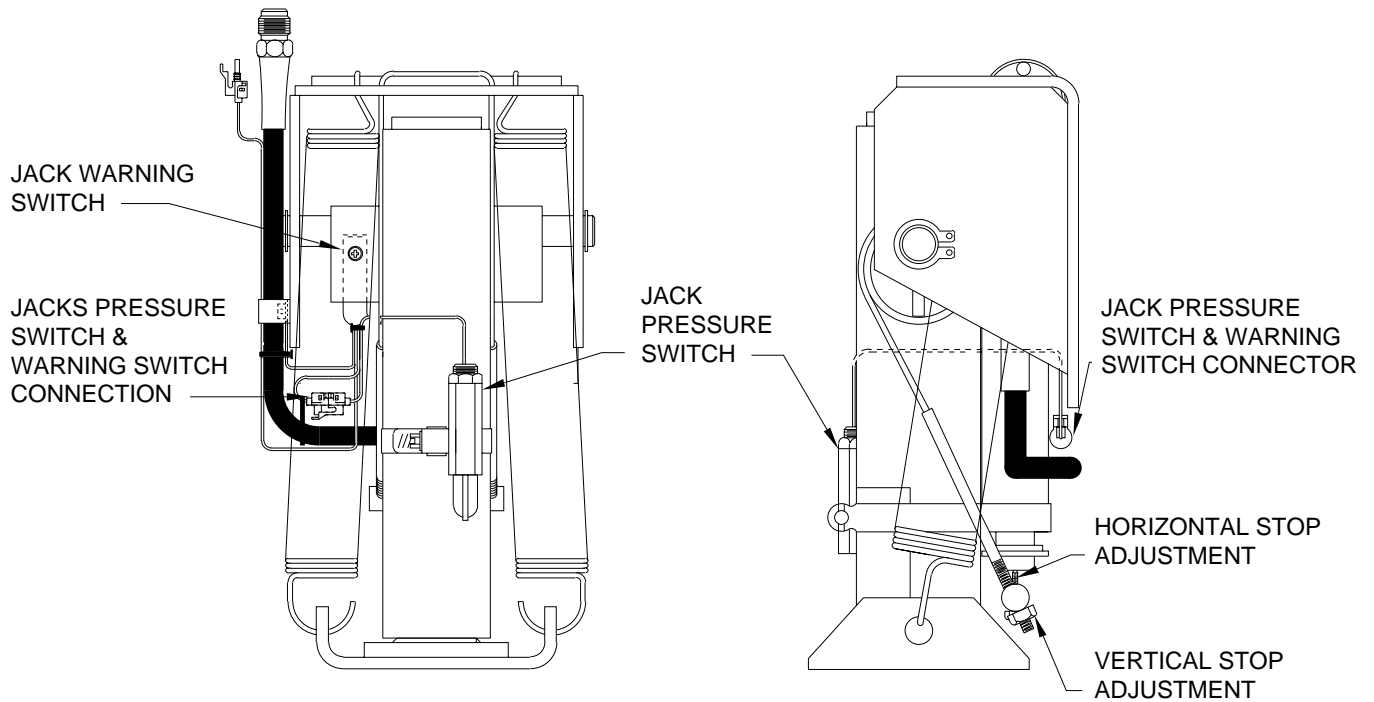

---

**9,000# CAPACITY JACK  
WITH PRESSURE SWITCH  
FOR 610 SERIES LEVELING SYSTEMS**

---

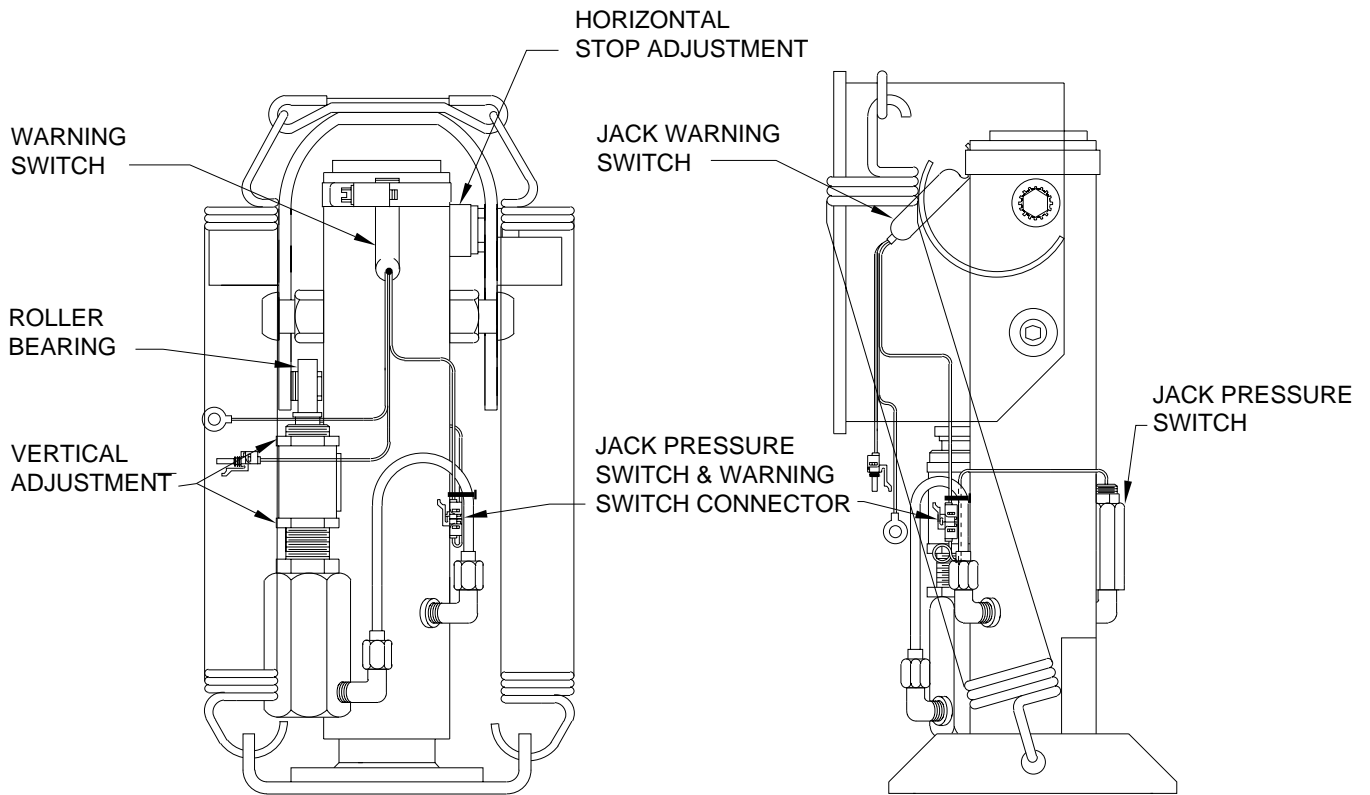

---

**16,000# CAPACITY JACK  
WITH PRESSURE SWITCH  
FOR 610 SERIES LEVELING SYSTEMS**

---

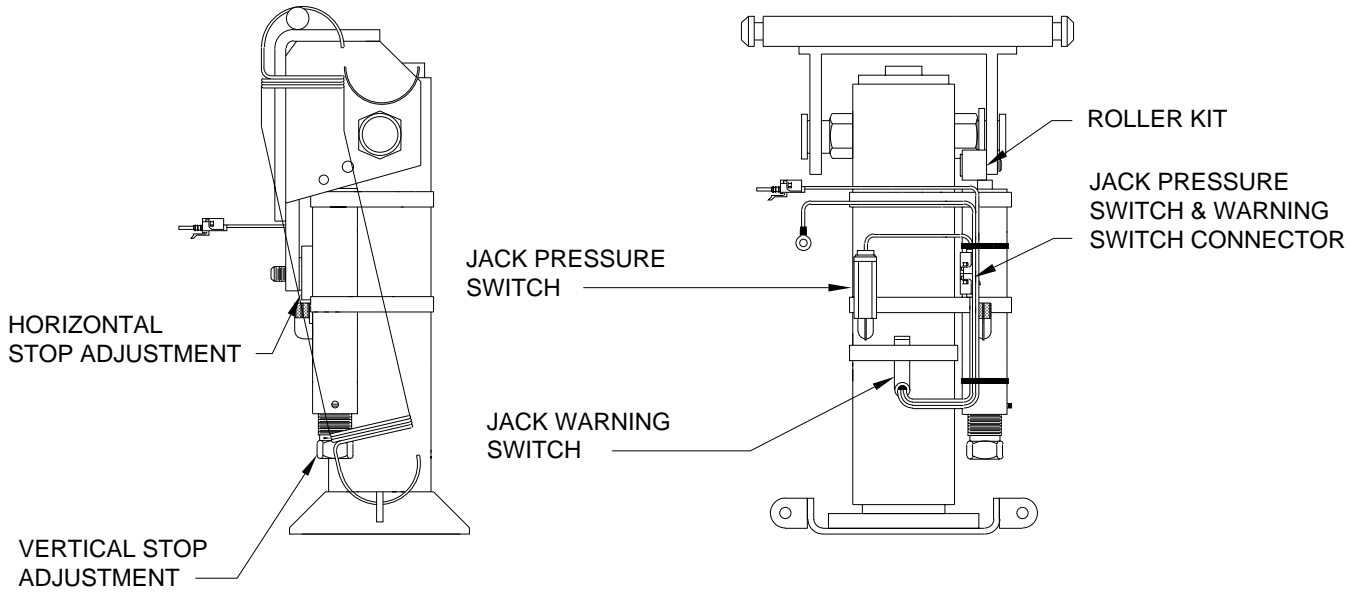

---

## MASTER LIGHT CONNECTION DIAGRAM COMPUTER-CONTROLLED 610 SERIES LEVELING SYSTEMS

---

**CAUTION:** THE PURPLE WIRE IN THE MASTER WARNING LIGHT HARNESS IS HOT WHENEVER THE IGNITION IS "ON" OR IN "ACC". THE PURPLE WIRE MUST BE REMOVED FROM THE HARNESS WHEN USING DIRECT IGNITION VOLTAGE FOR THE MASTER WARNING INDICATORS.

**NOTE:** THE (4) DIGIT WIRE NUMBER SUPERSEDES ANY AND ALL WIRE COLORS.

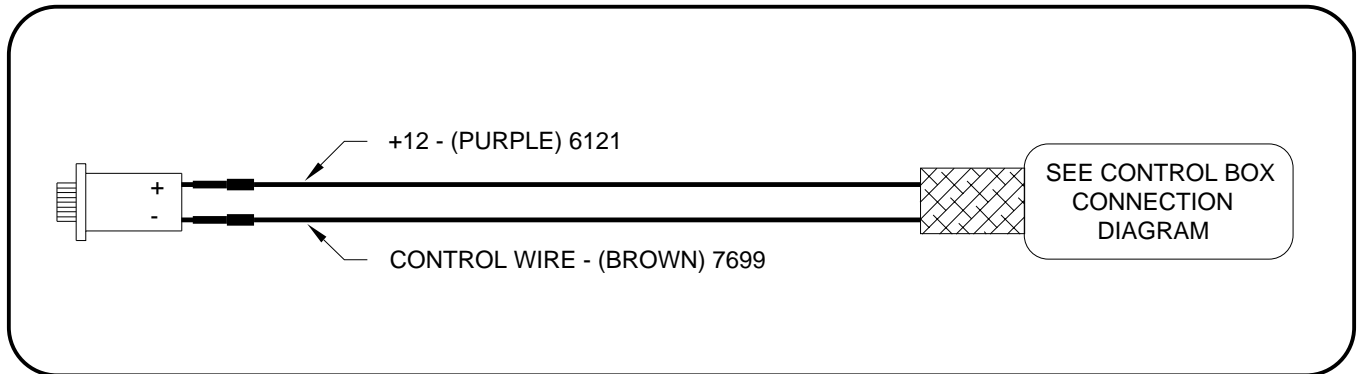

---

# MOUNTING AND ADJUSTMENT INSTRUCTIONS

## LEVEL SENSING UNIT

---

The sensing unit must be mounted to a solid surface and must not be exposed to any heat sources. Toward the middle of the vehicle but outside the frame rails is best. The sensing unit may be mounted between frame rails on pusher vehicles and trailers. The sensing unit may be mounted in a compartment but needs to be protected from stored objects. It is critical that the sensing unit is mounted in the proper position according to the sticker on the sensing unit. (See figure below). The springs should be compressed to approximately 1.25 inches.

The correct method for adjusting the sensor is as follows:

First, level the vehicle by placing a 24" level in the center of the vehicle on the floor. With the vehicle level adjust the sensing unit until all yellow lights are out. This is done by drawing up or backing out the sensing unit screws. If a front light is on, adjust the front screw. If a side light is on adjust the side screw. If a rear light is on adjust the rear screws. One or more screws may have to be adjusted to turn the yellow lights out. After adjustment has been made, pull down on the sensing unit to make sure the unit is bottomed out on the screw heads. Check to make sure all yellow lights are out. If not, readjust. Rock the vehicle and recheck for yellow lights, readjust if needed.

**NOTE:** The sensing unit has an accuracy tolerance of +/- 1" side to side and +/- 5.4" front to rear on a 36' vehicle.

